



My First Computer (Adore Edition)

A LEGO® project by Chris McVeigh
chrismcveigh.com



































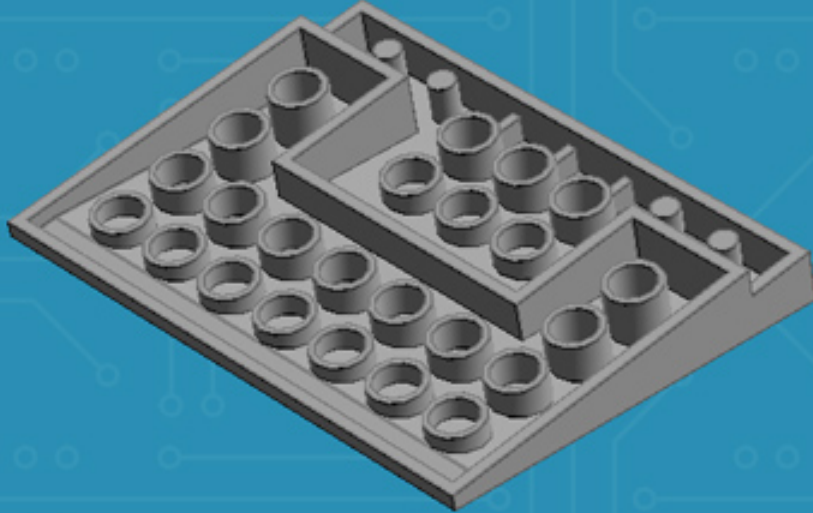
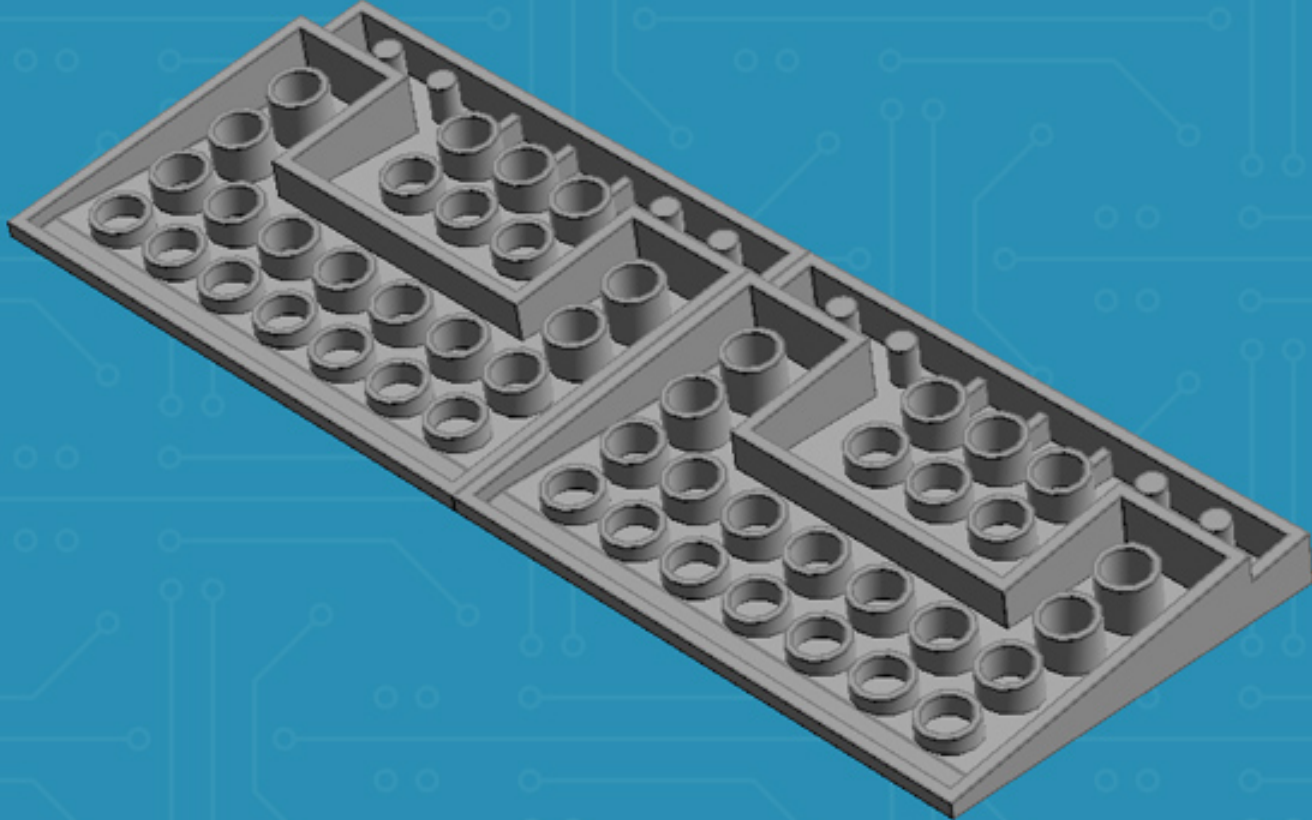
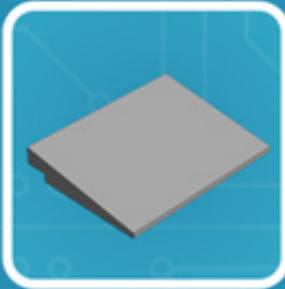
Image	Element ID	Color	Description	Quantity
	302326	Black	Plate, 1x2	2
	4286009	Black	Plate, 1x8, With Rail	1
	302126	Black	Plate, 2x3	2
	303426	Black	Plate, 2x8	1
	614126	Black	Plate, Round, 1x1	2
	4558170	Black	Tile, 1x3	2
	4653988	Dark Azure	Plate, 1x2	1
	4211098	Dark Grey	Brick, 1x1	1
	4211133	Dark Grey	Plate, 1x3	1
	4212471	Green	Bracket, 1x2 / 2x2	2
	4243821	Green	Plate, 4x4	1
	4518653	Light Grey	Bowed Roof Ridge 2x4x1	4
	4211389	Light Grey	Brick, 1x1	4
	4211394	Light Grey	Brick, 1x4	3
	4211366	Light Grey	Brick, 1x16	1
	4558953	Light Grey	Brick, Modified, 1x1 W. 1 Stud	3
	6015344	Light Grey	Brick, Modified, 1x2 W. 2 Studs	3

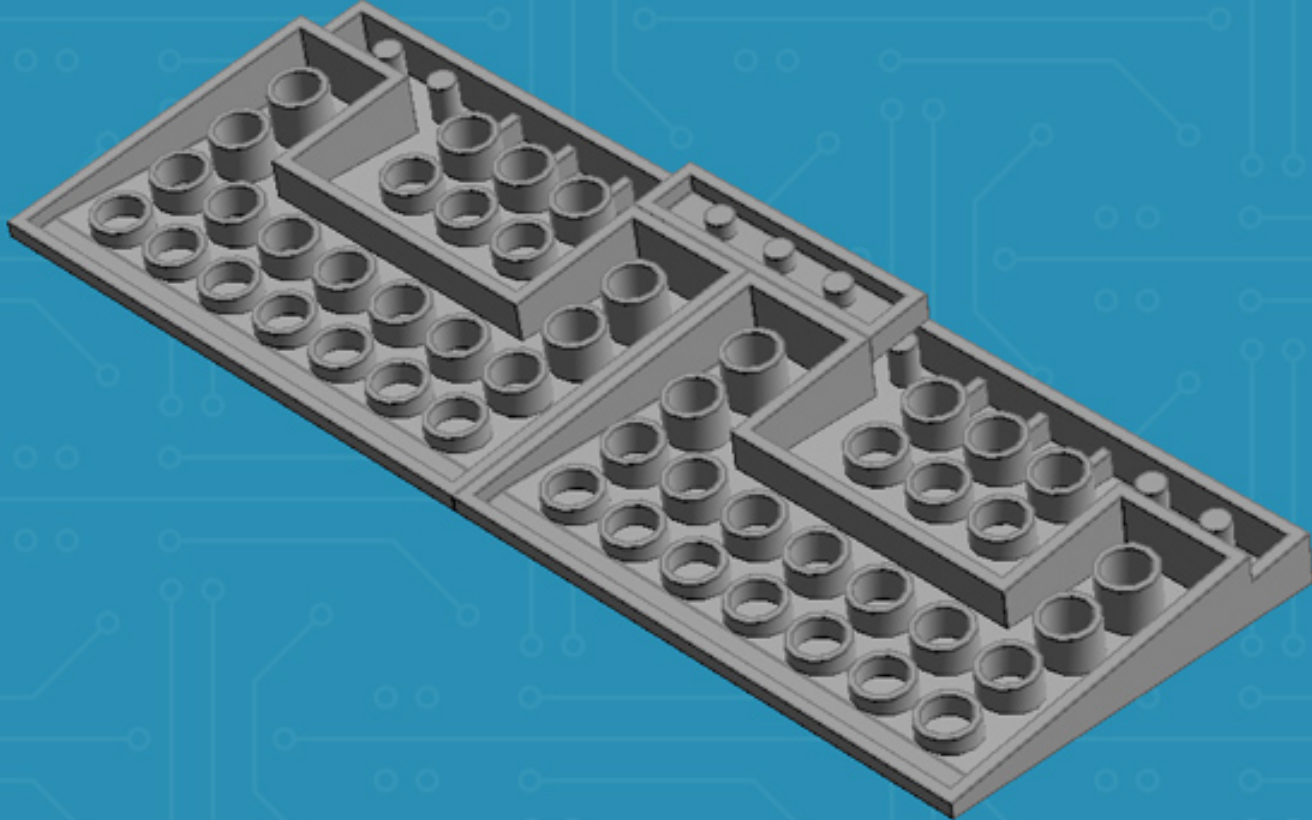


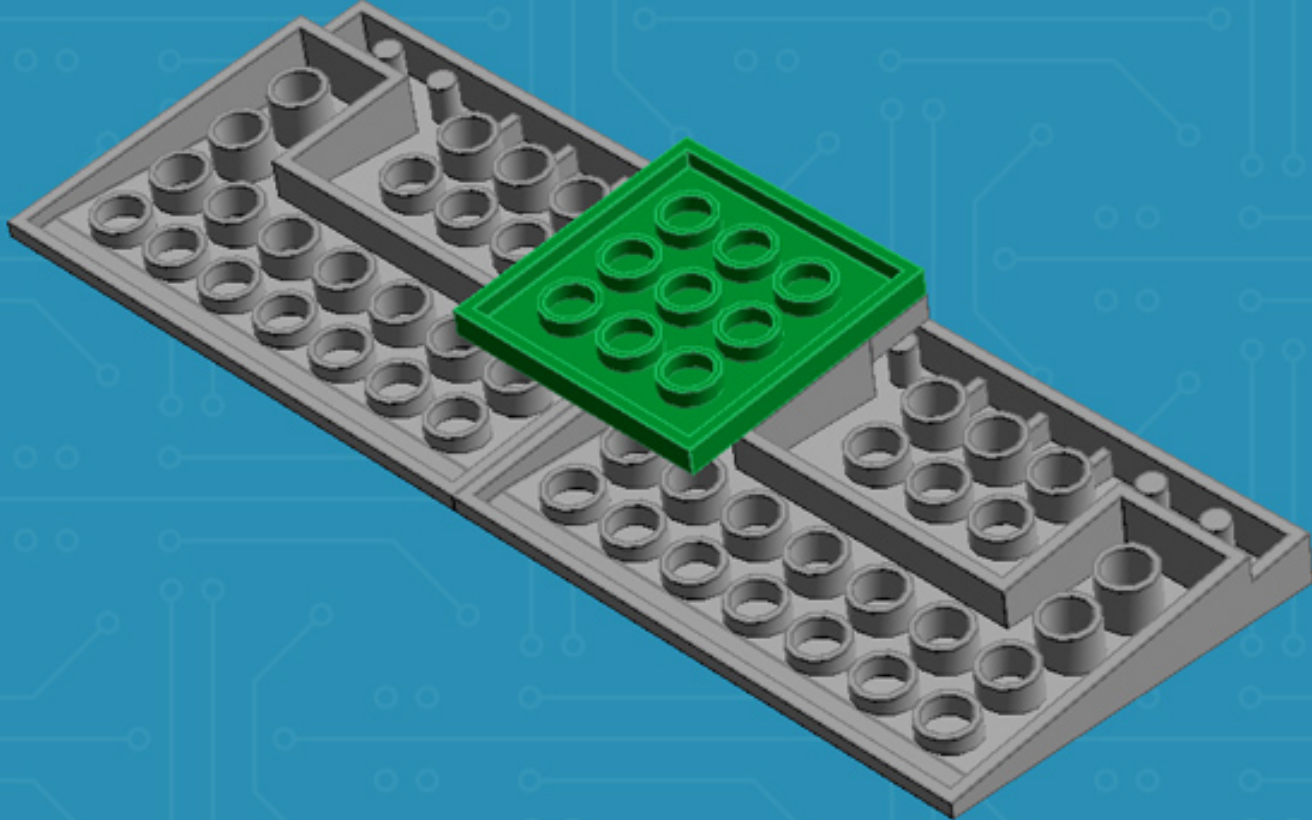
Image	Element ID	Color	Description	Quantity
	4211636	Light Grey	Brick, Modified, 1x4 W. 4 Studs	4
	4211383	Light Grey	Brick, Modified, 1x2 with Grill (Profile Brick)	6
	4539481	Light Grey	Light Sword Shaft	2
	4597901	Light Grey	Plate W. Bow 2x4x2/3	4
	4211398	Light Grey	Plate, 1x2	6
	4211445	Light Grey	Plate, 1x4	2
	4211425	Light Grey	Plate, 1x8	3
	4211360	Light Grey	Plate, 2x12	1
	4211486	Light Grey	Plate, 2x16	2
	4211396	Light Grey	Plate, 2x3	1
	4211395	Light Grey	Plate, 2x4	3
	4211819	Light Grey	Ramp, 6x8	2
	4521921	Light Grey	Slope, 30°, 1x1x2/3	5
	4568637	Light Grey	Slope, 30°, 1x2x2/3	1
	302321	Red	Plate, 1x2	2
	4646864	Trans-Red	Tile, Round, 1x1	1
	302324	Yellow	Plate, 1x2	3

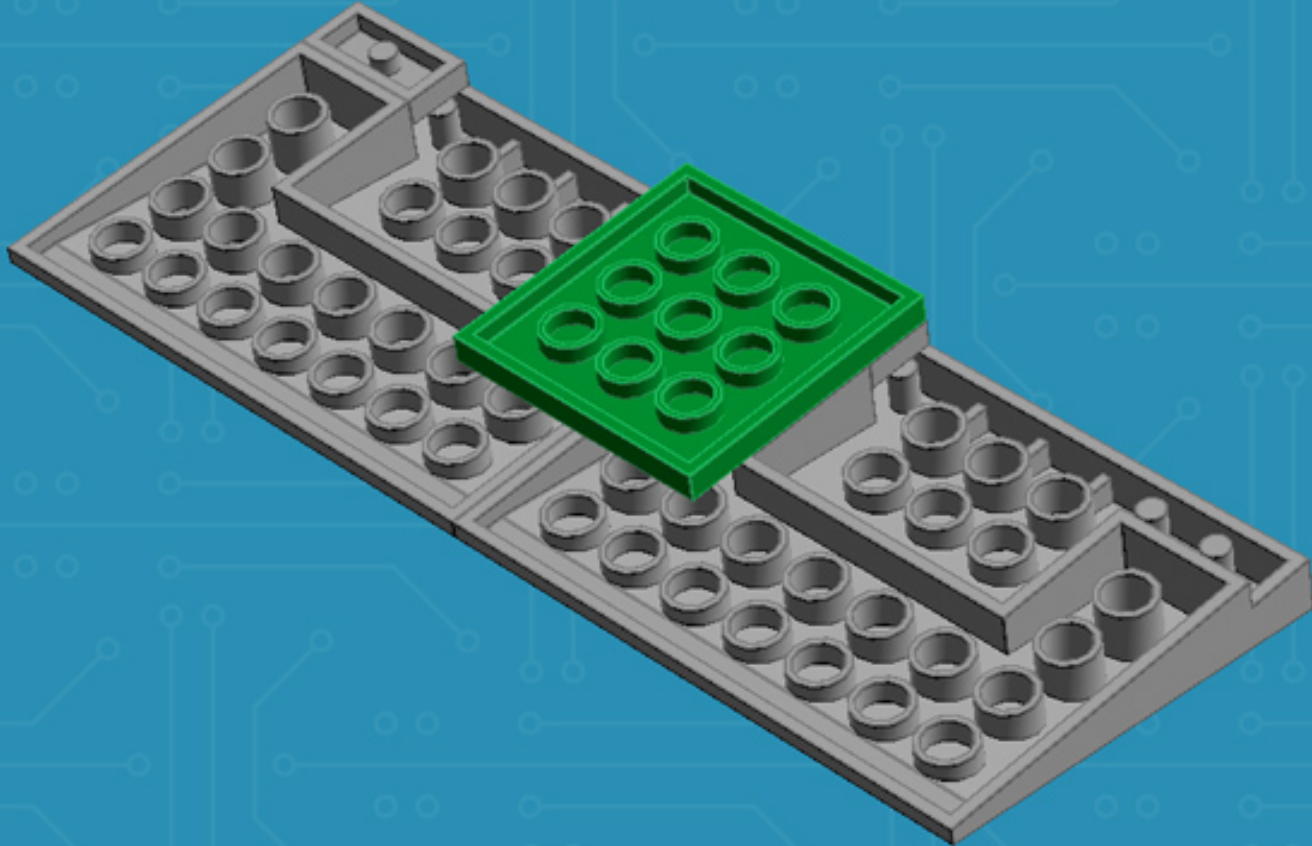


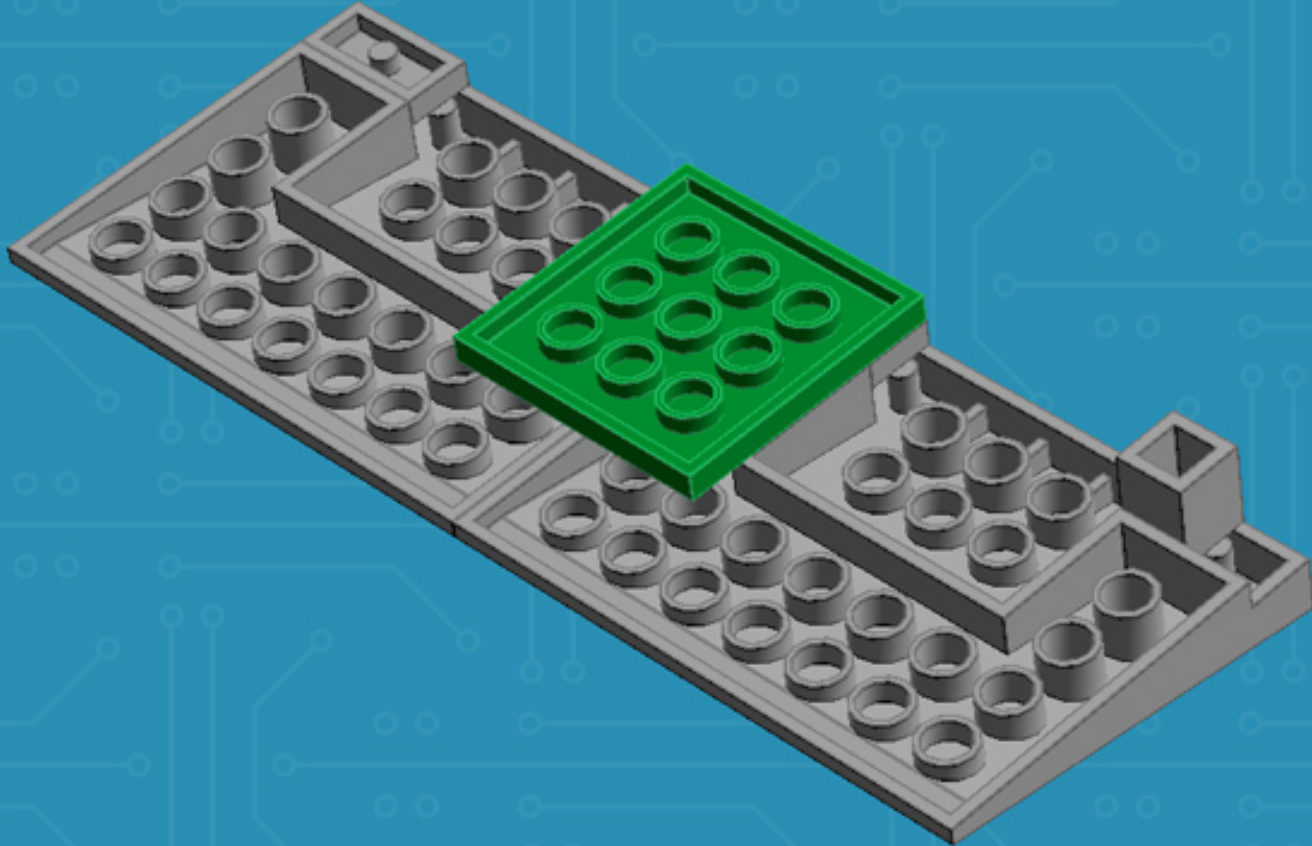


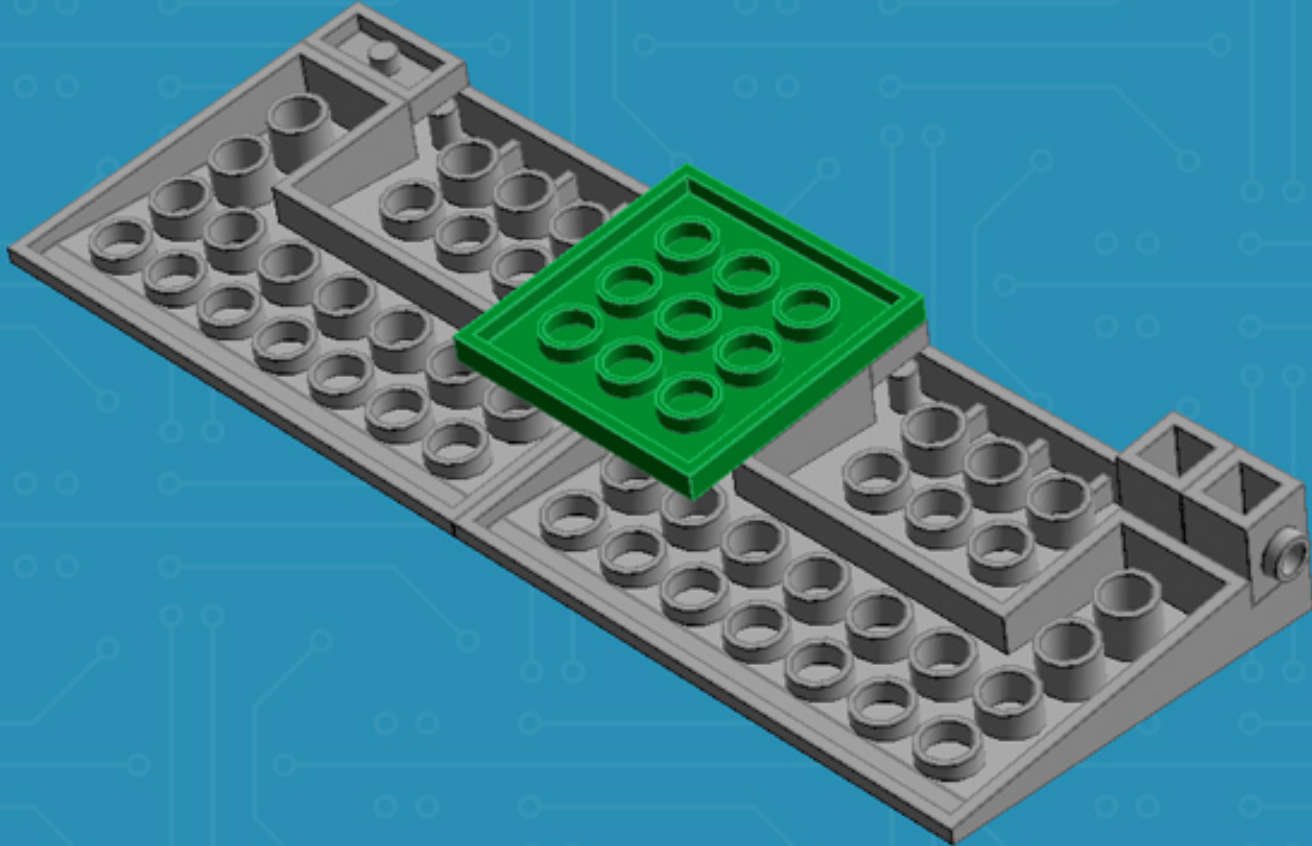


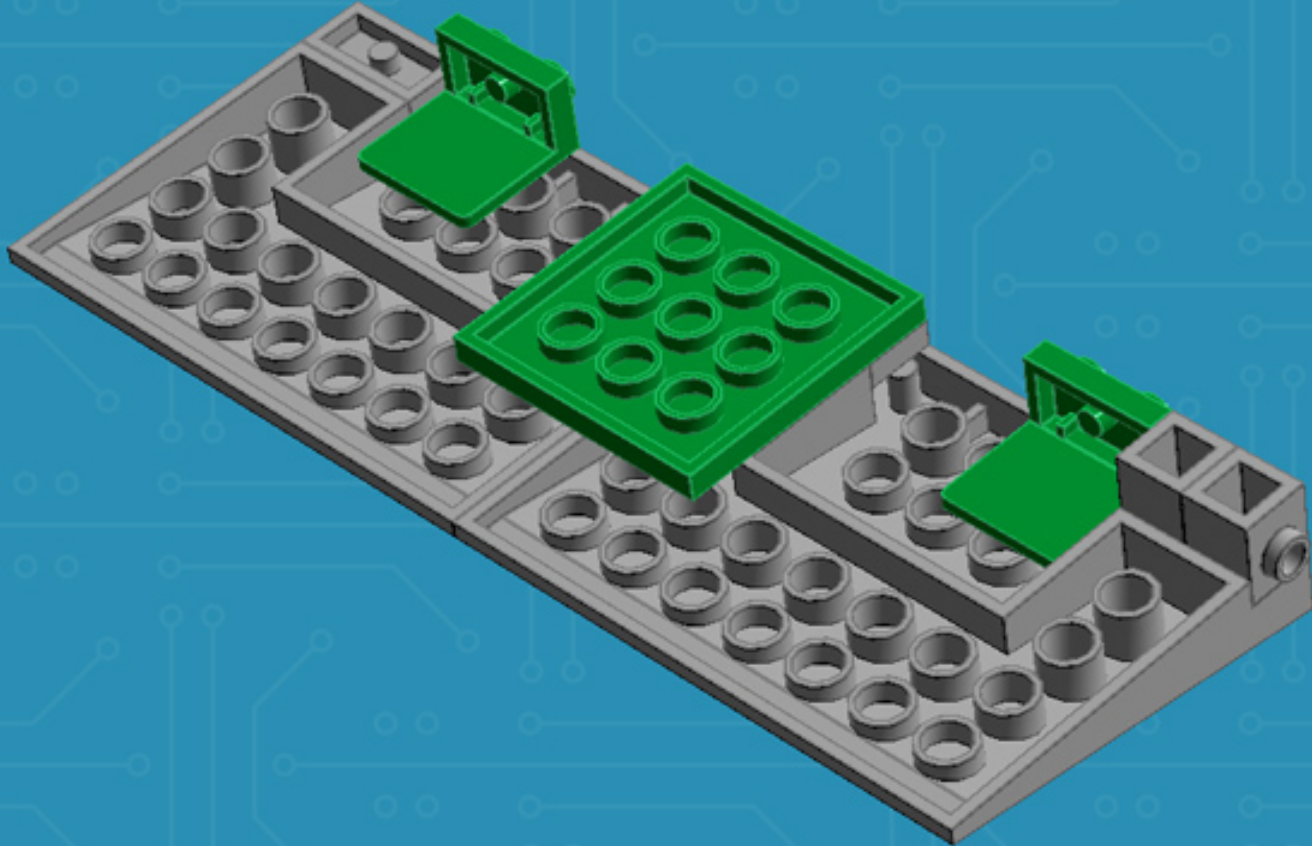


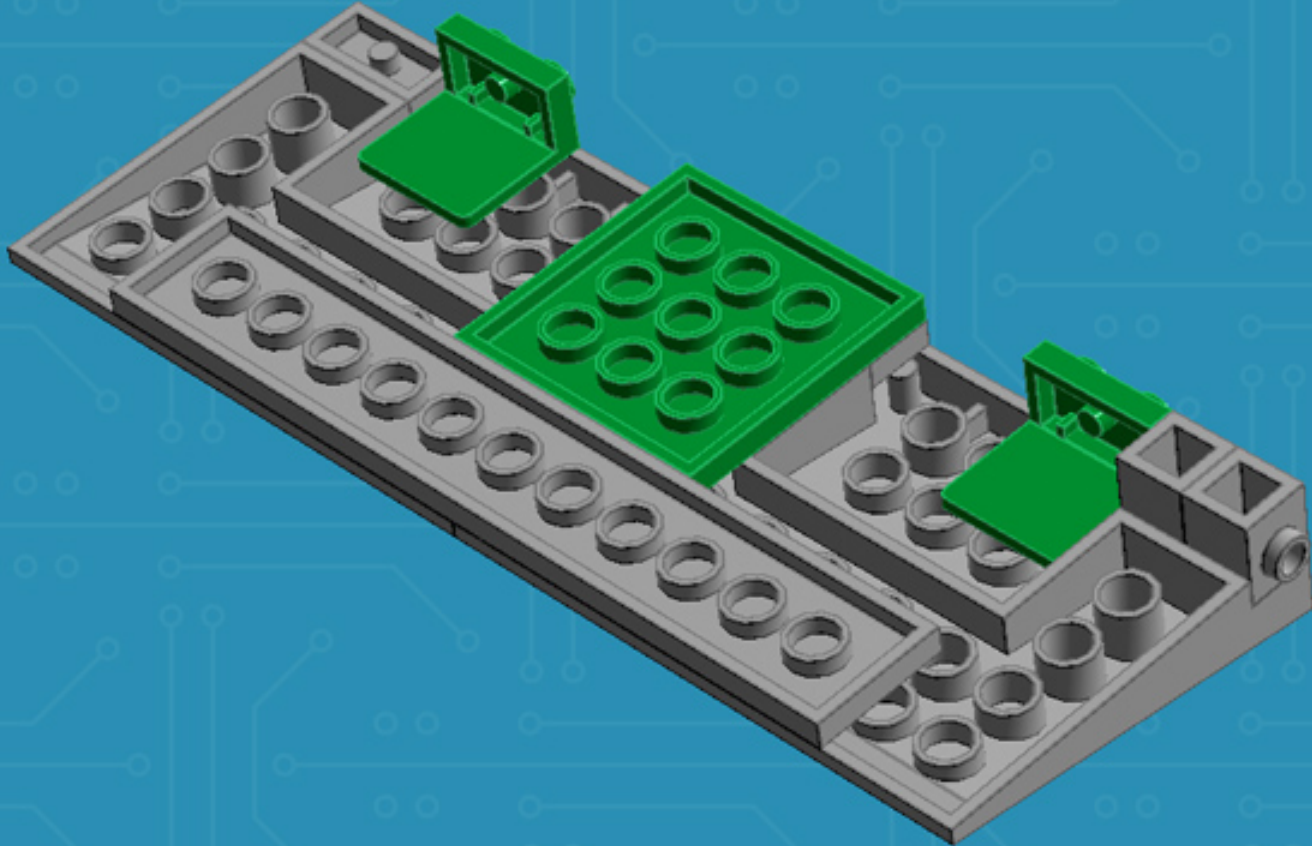


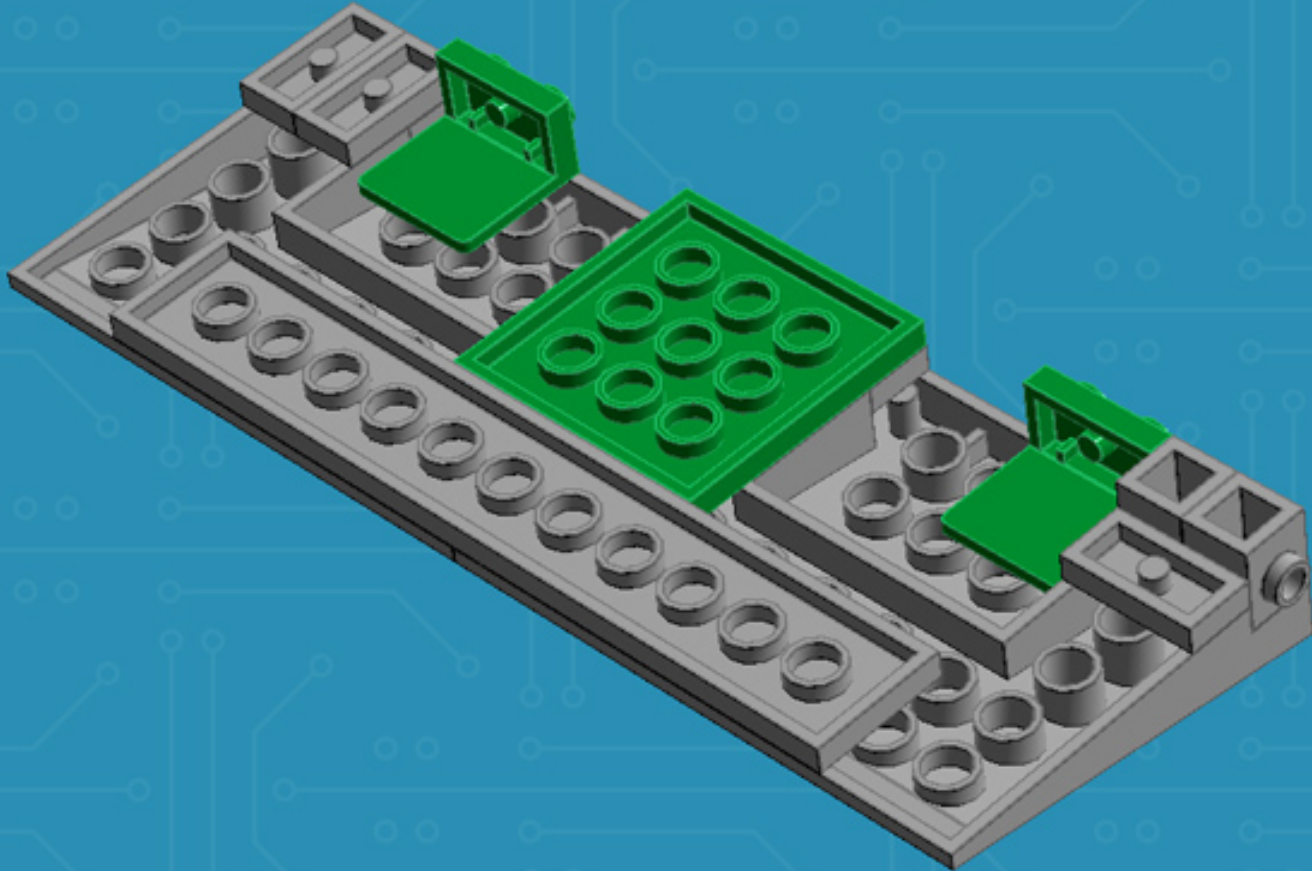


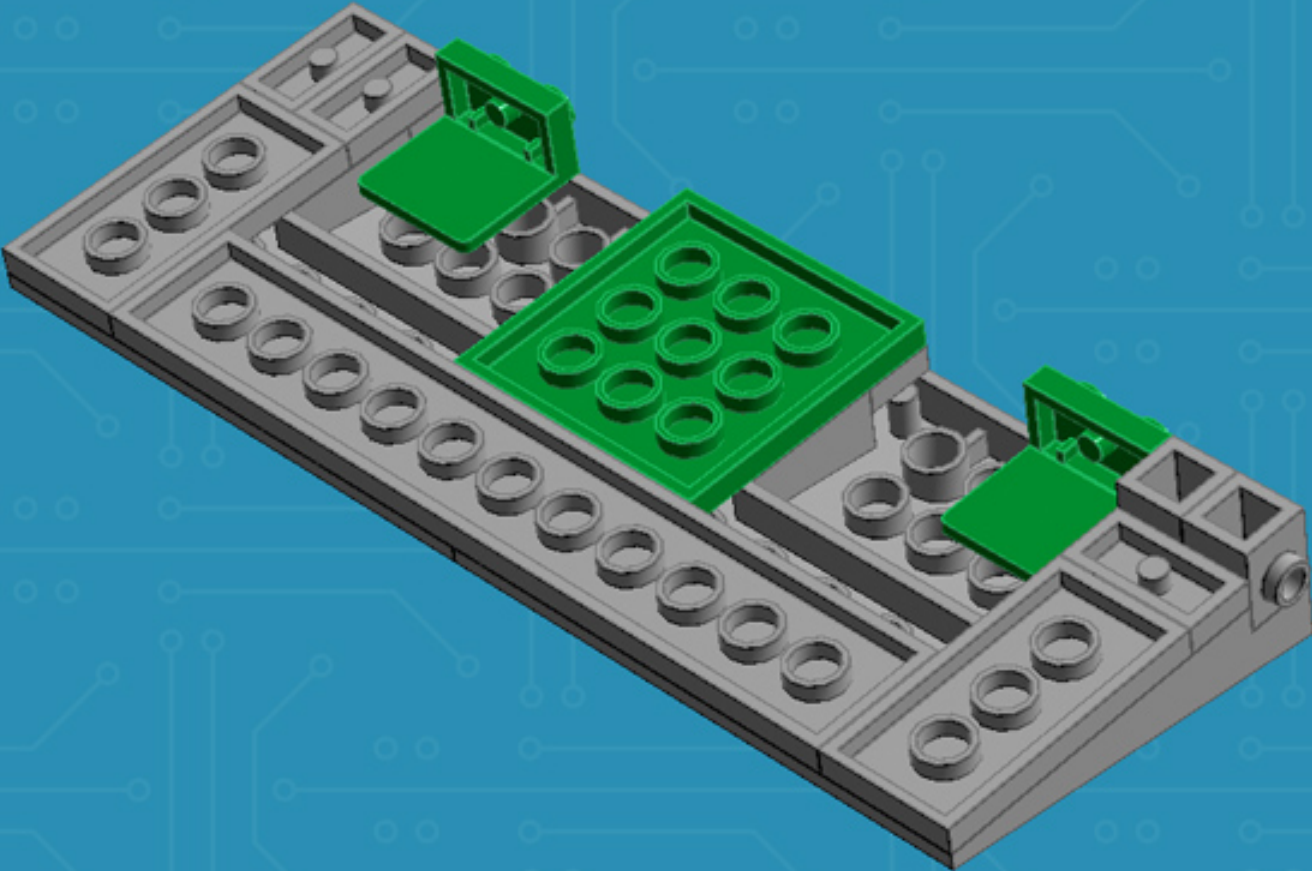


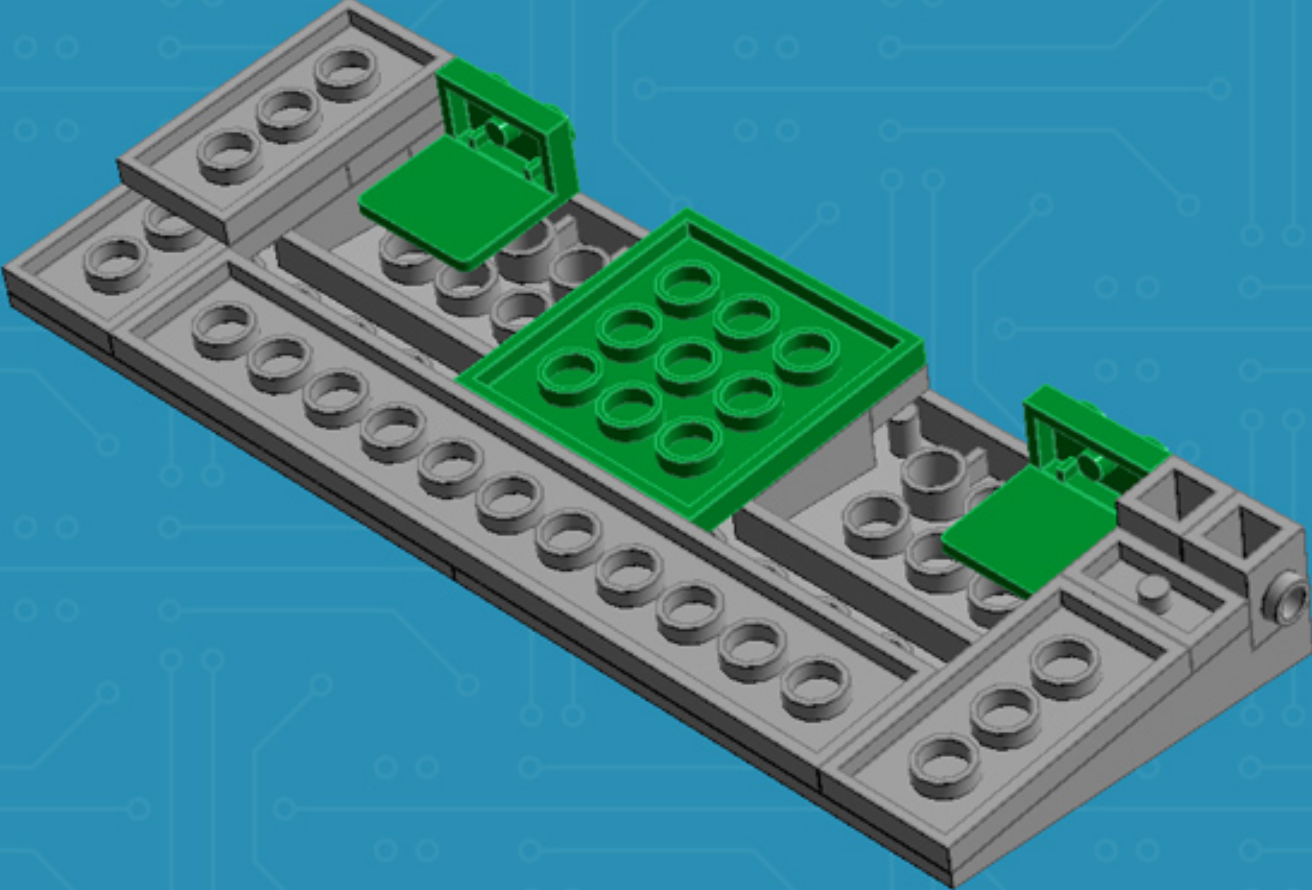


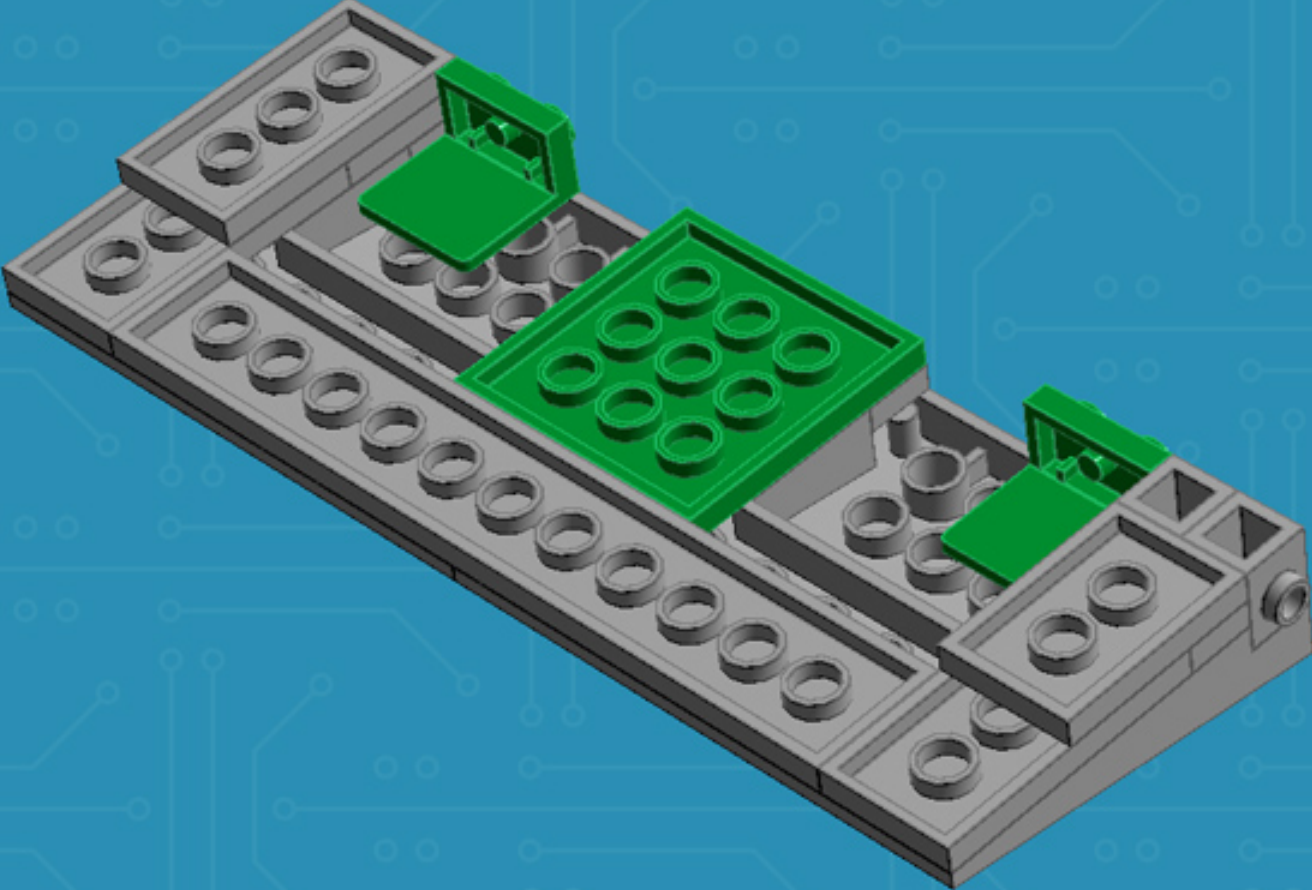


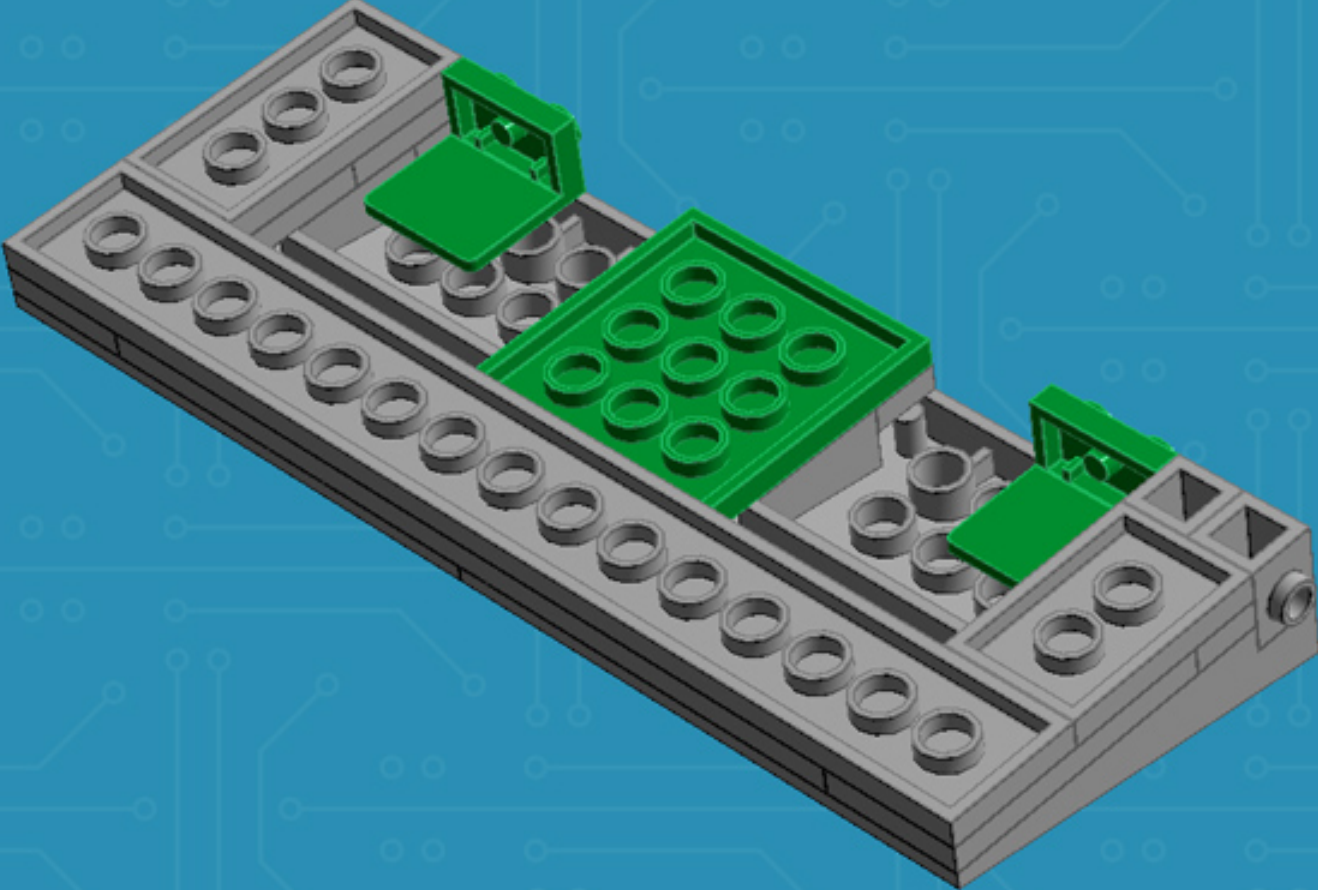


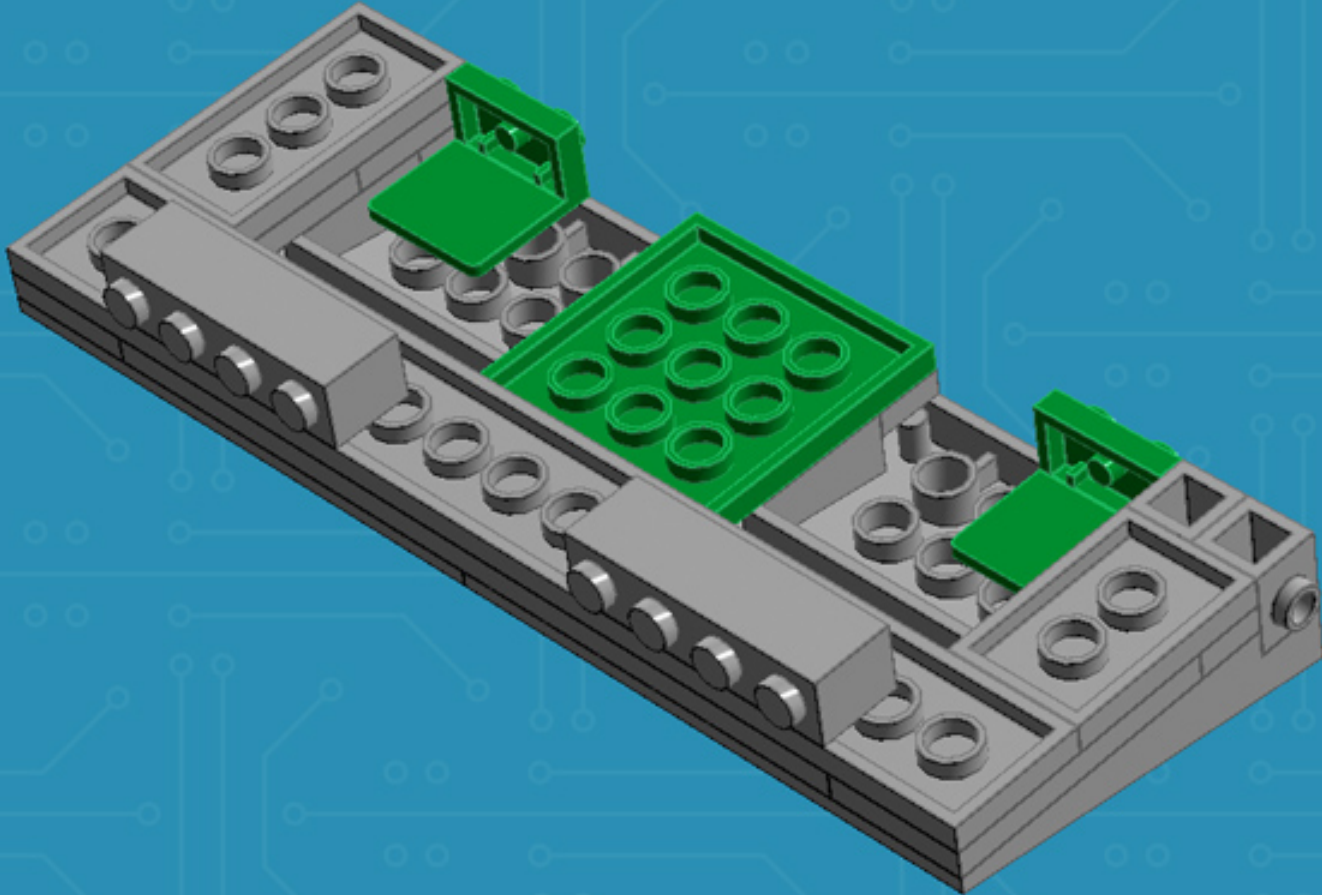


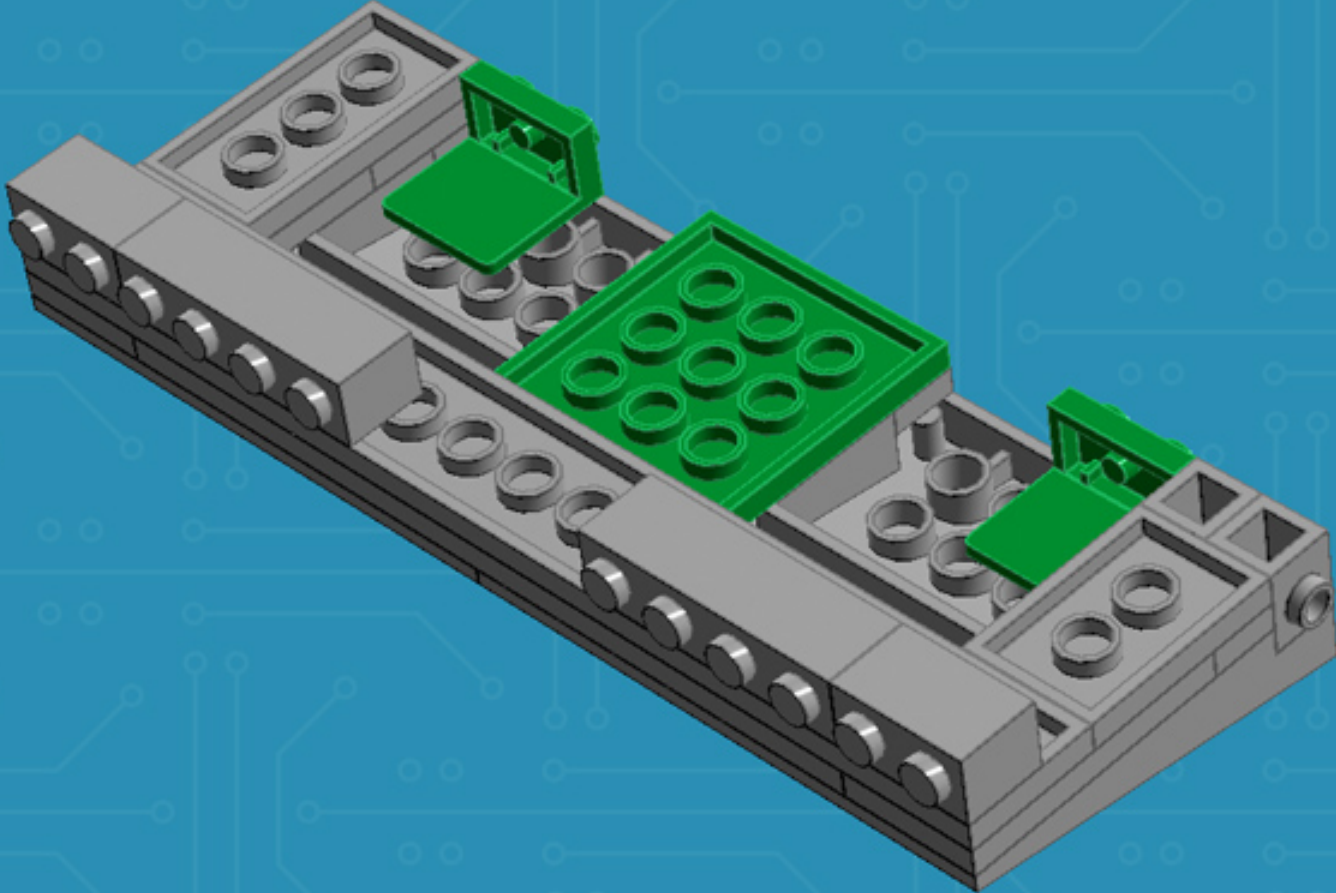


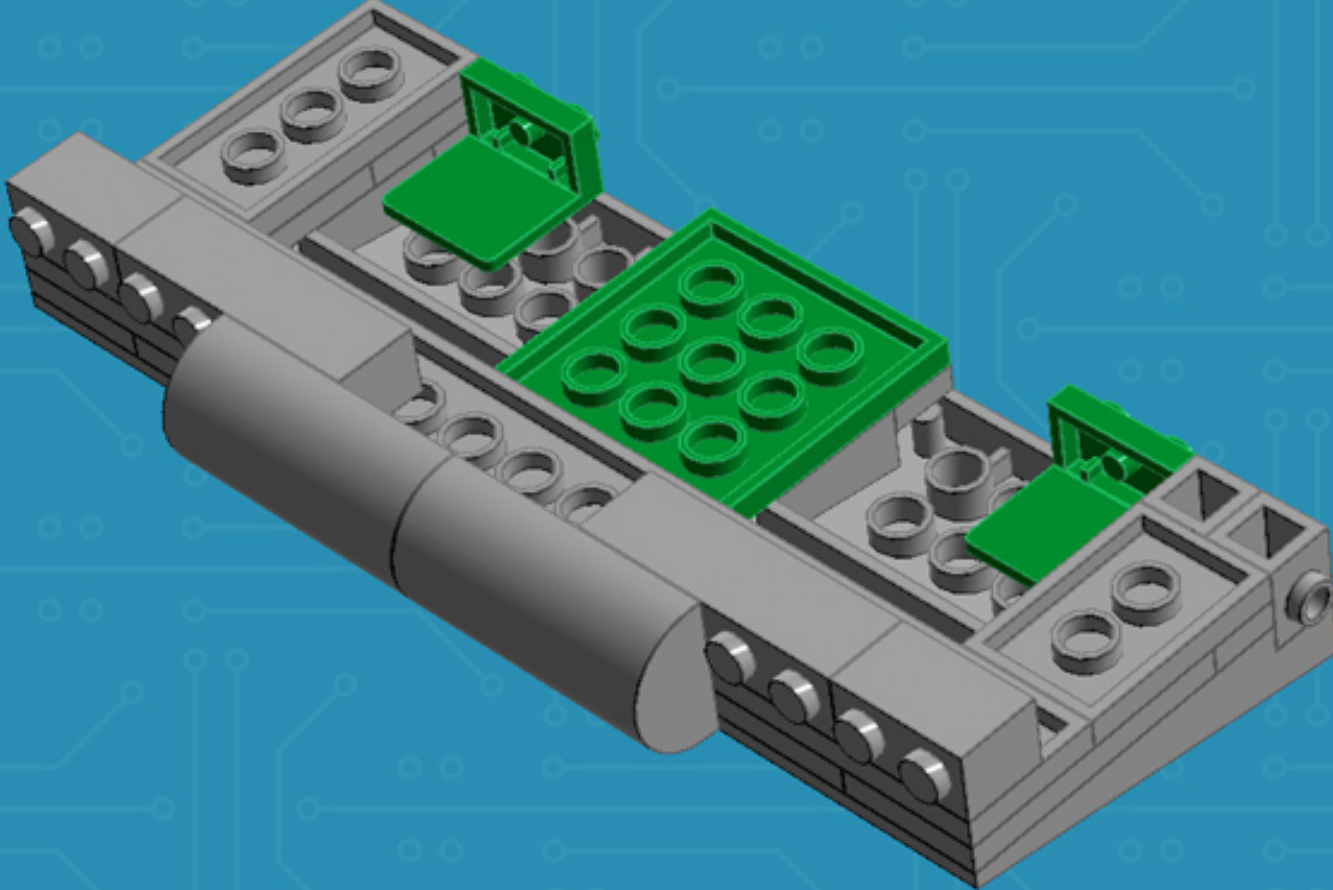
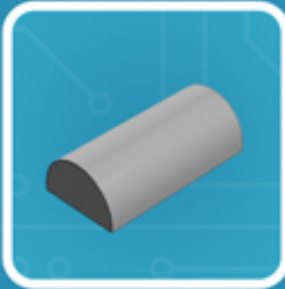


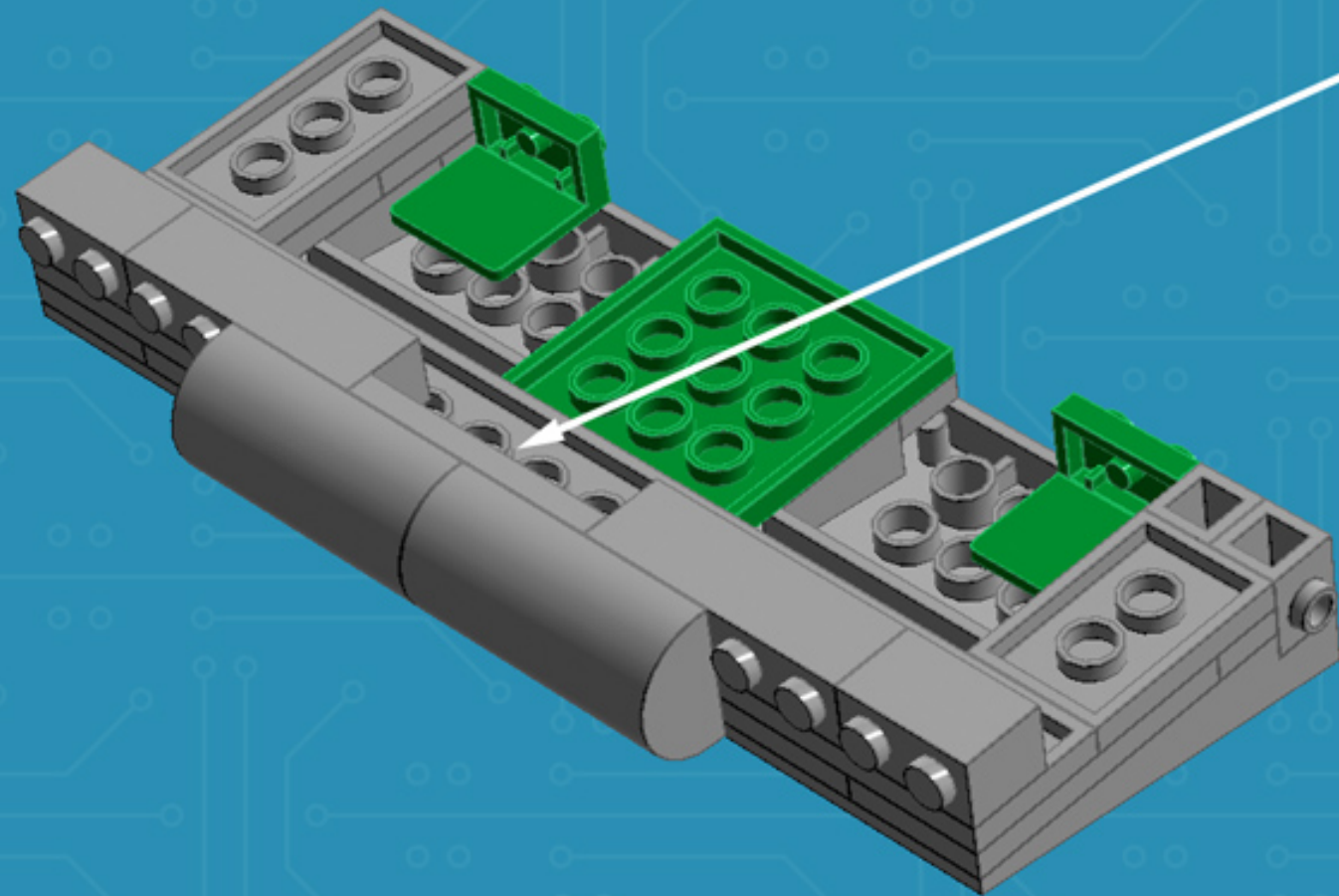


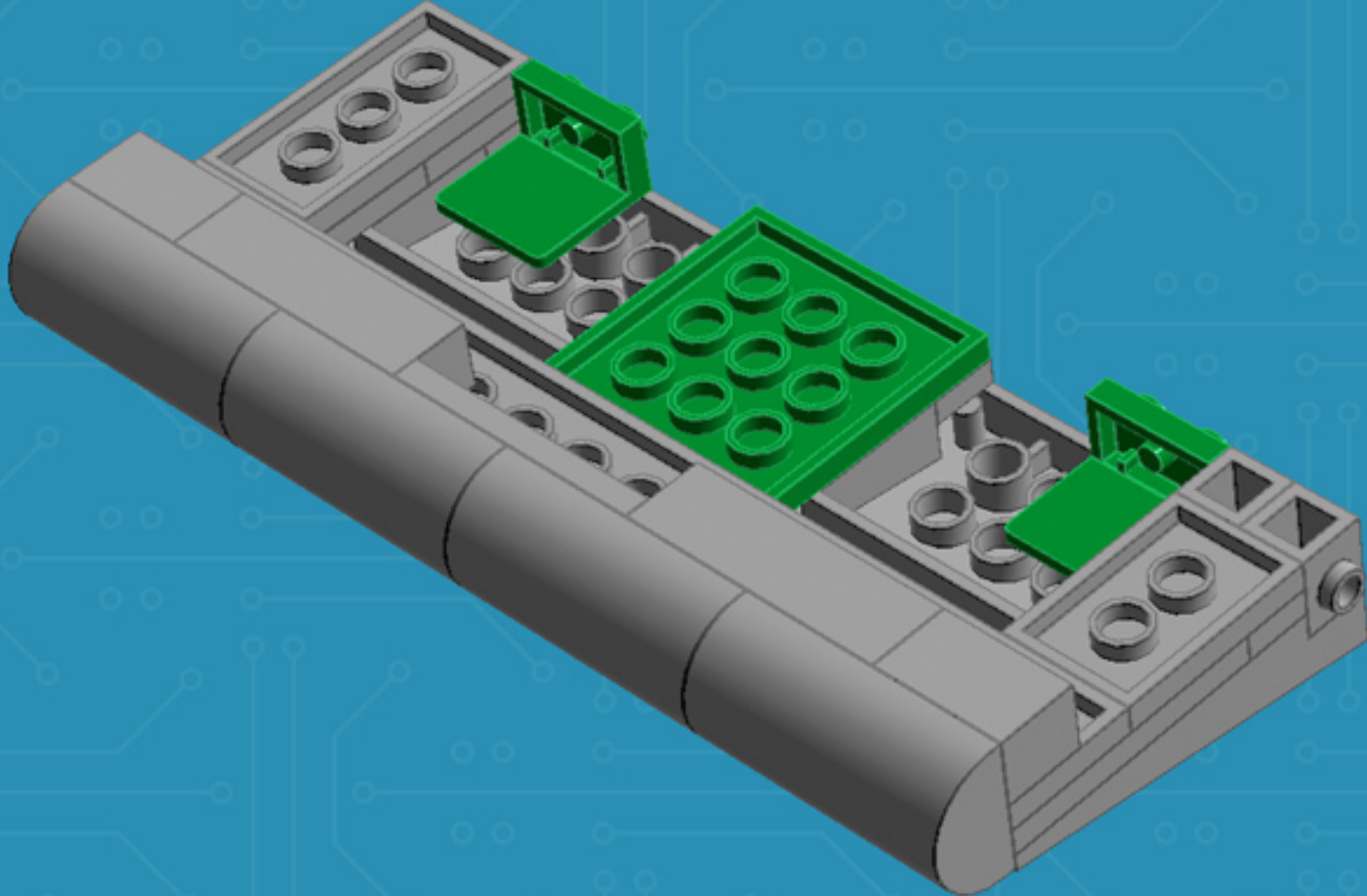
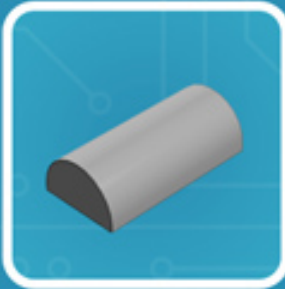


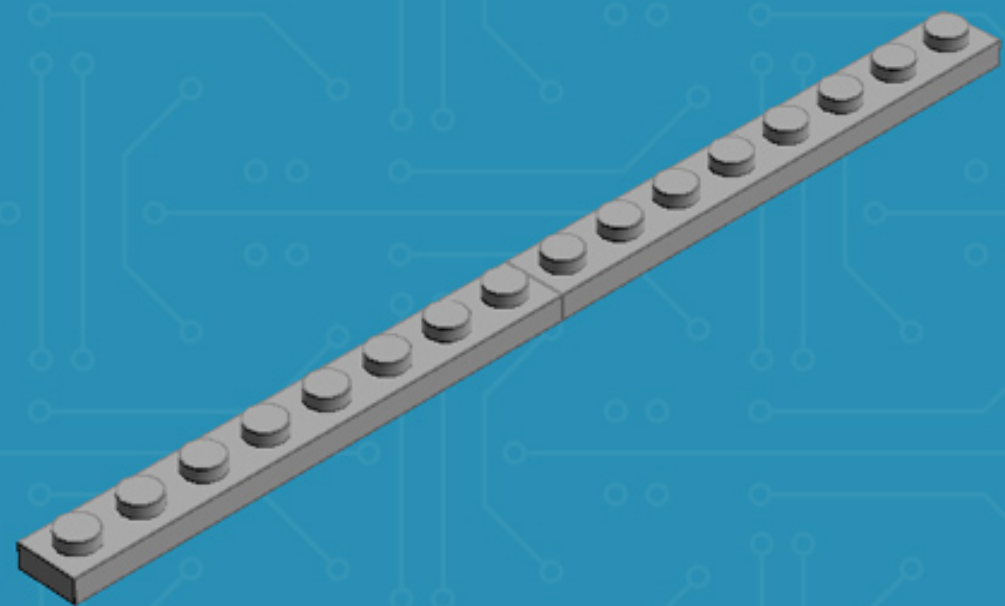


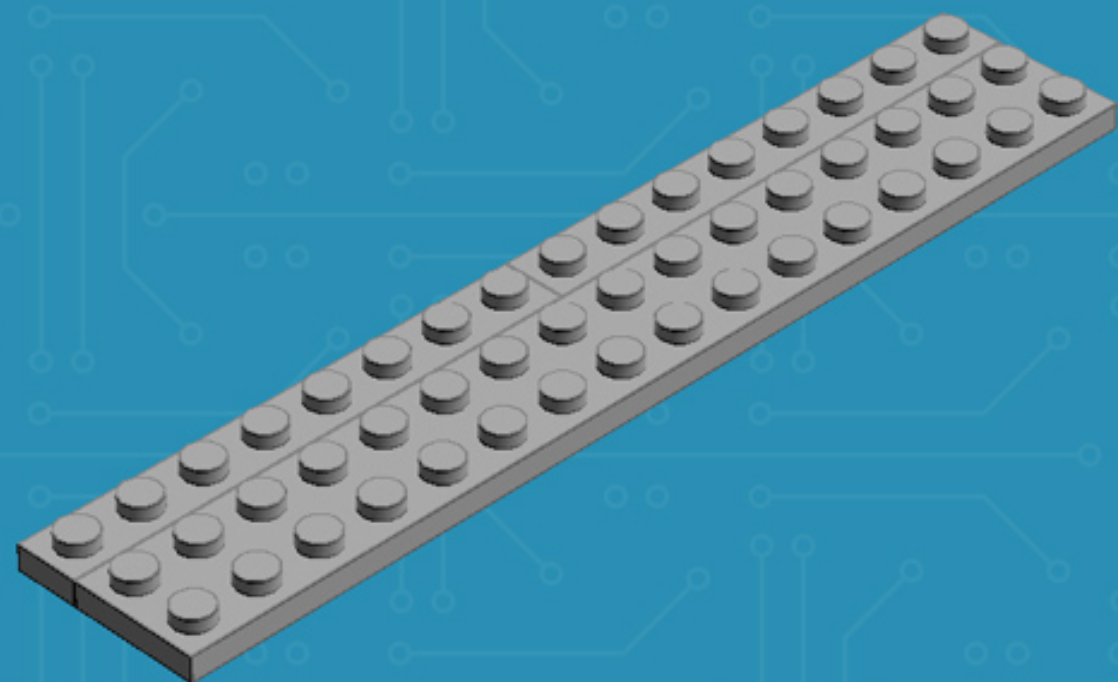


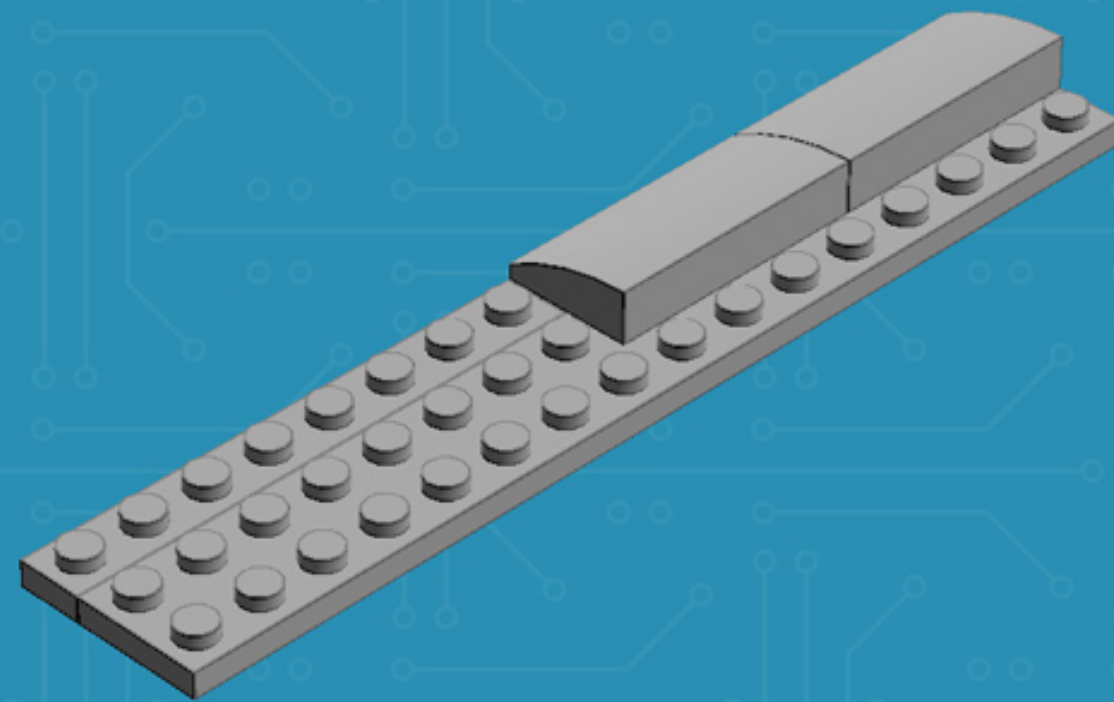


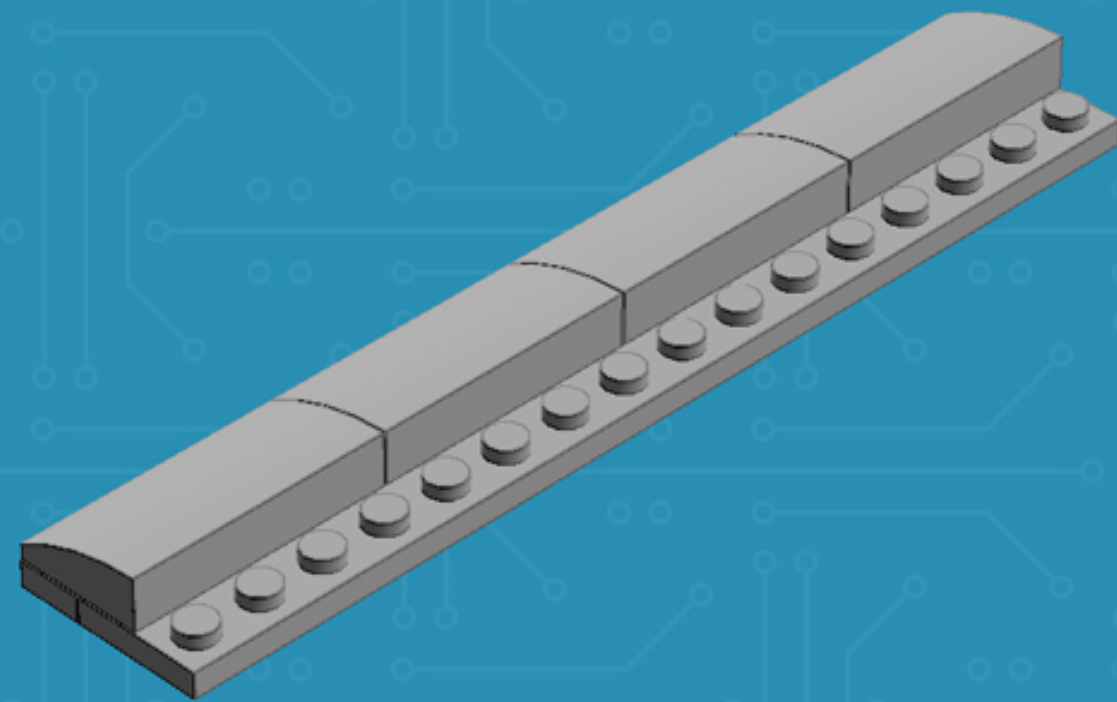


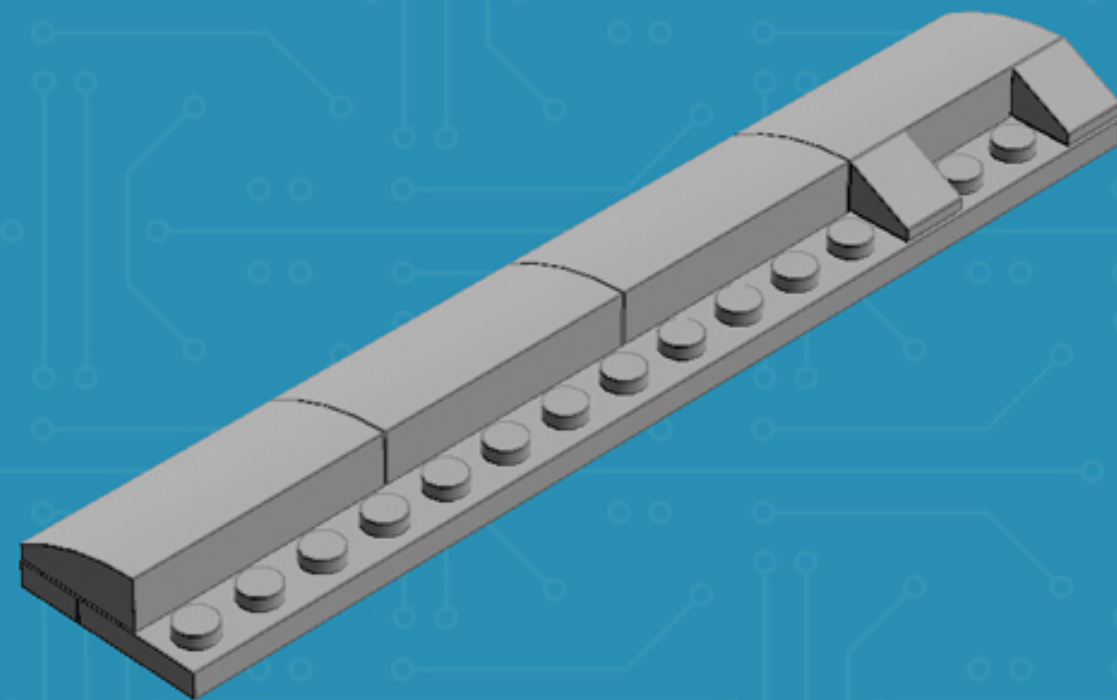


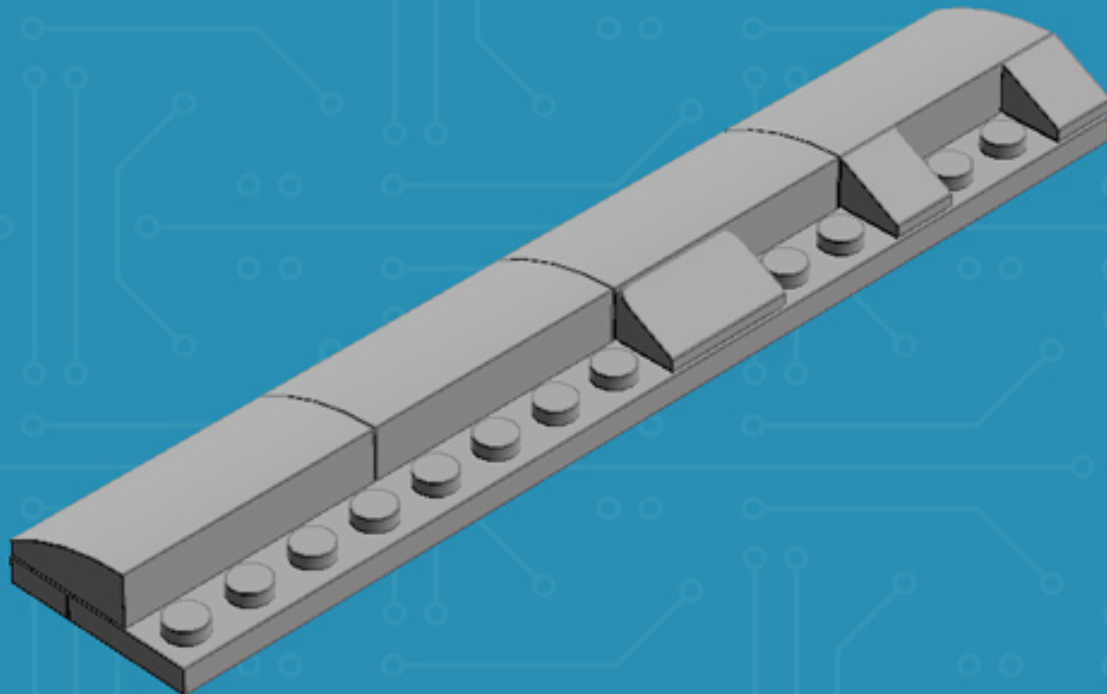


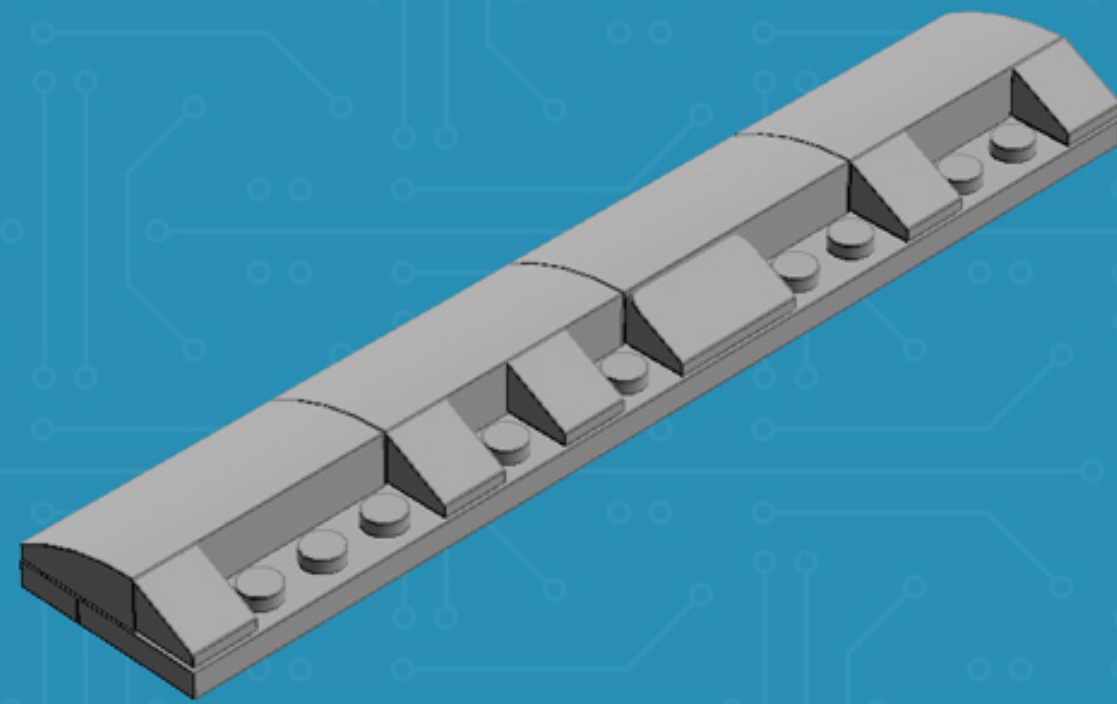


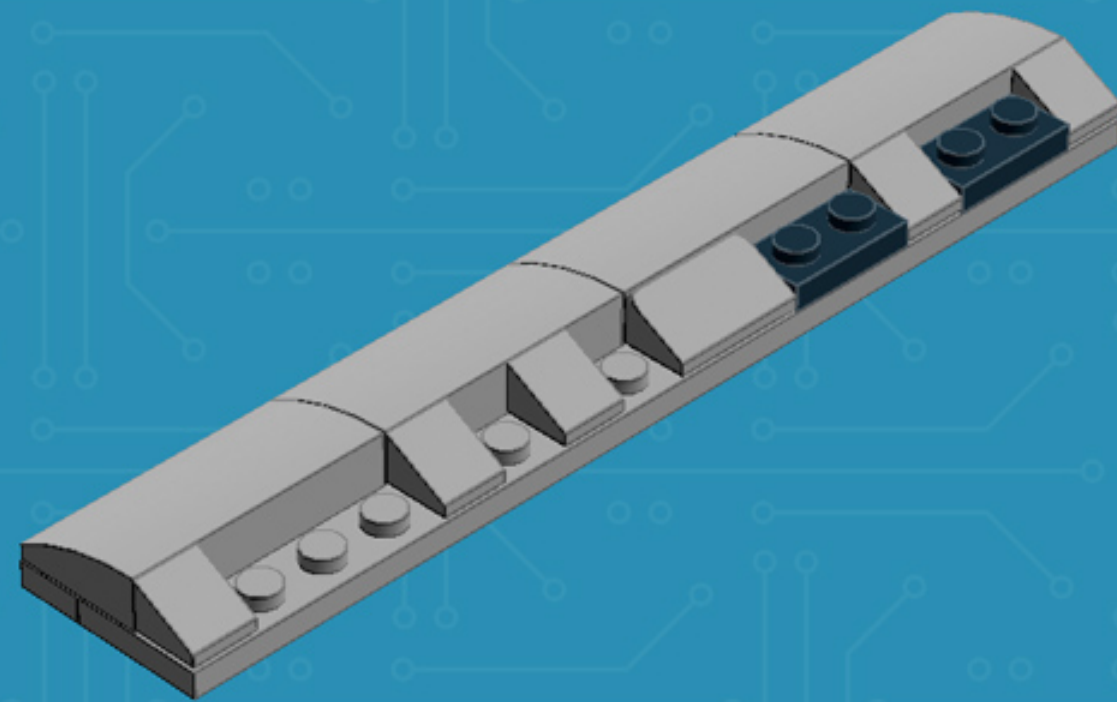


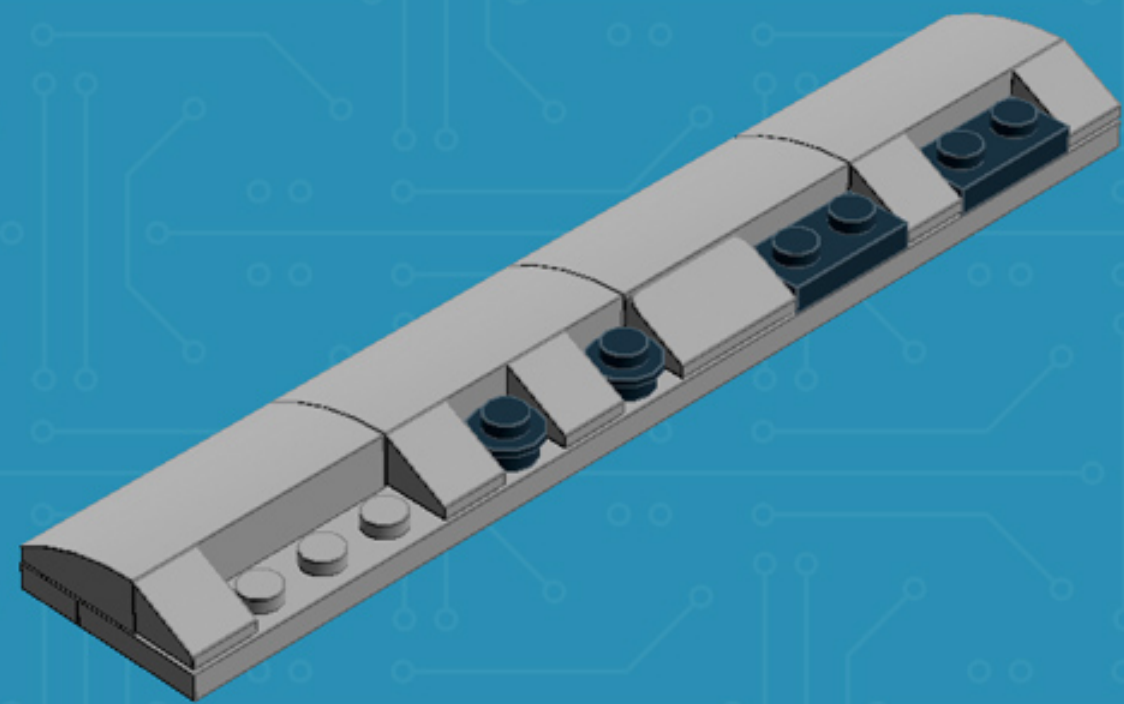


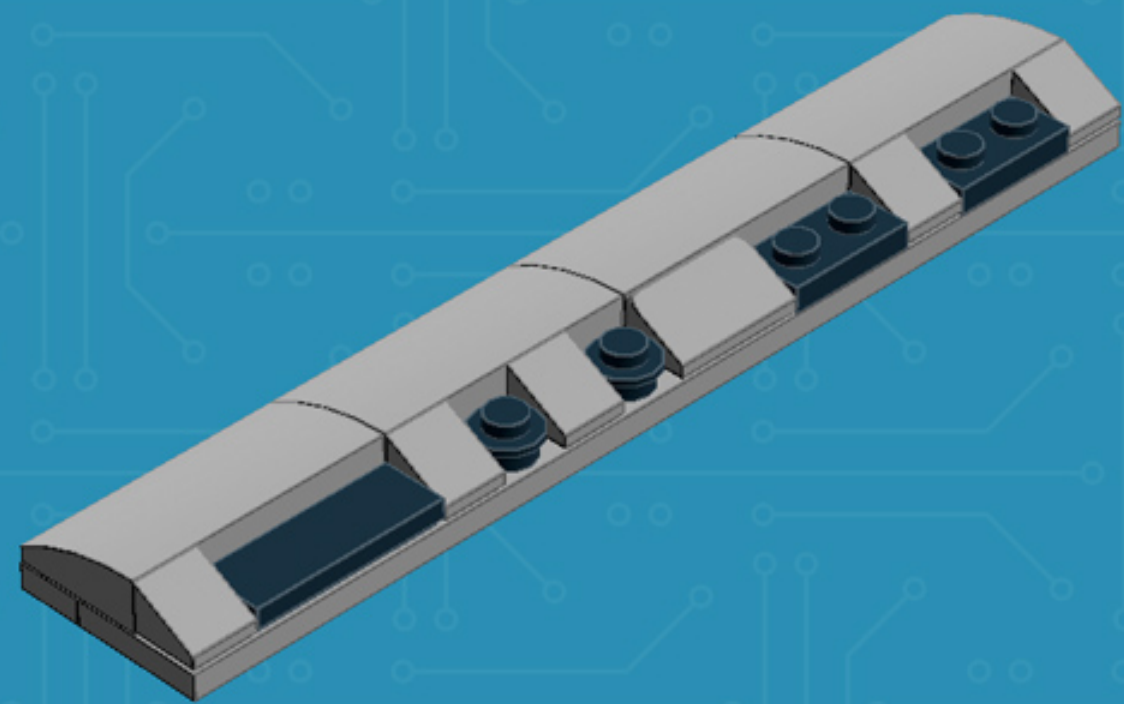


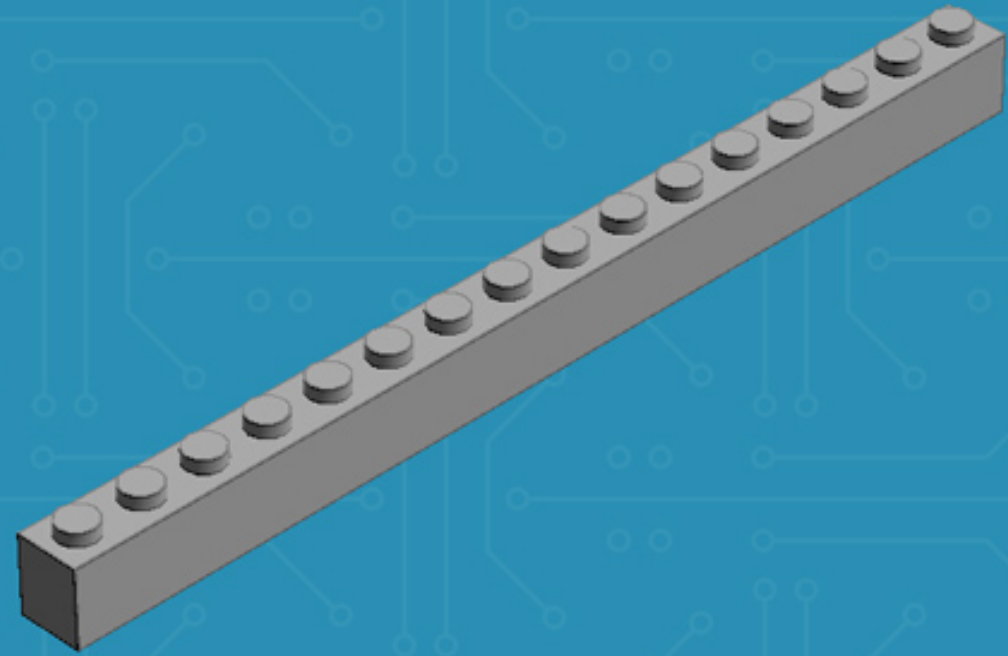


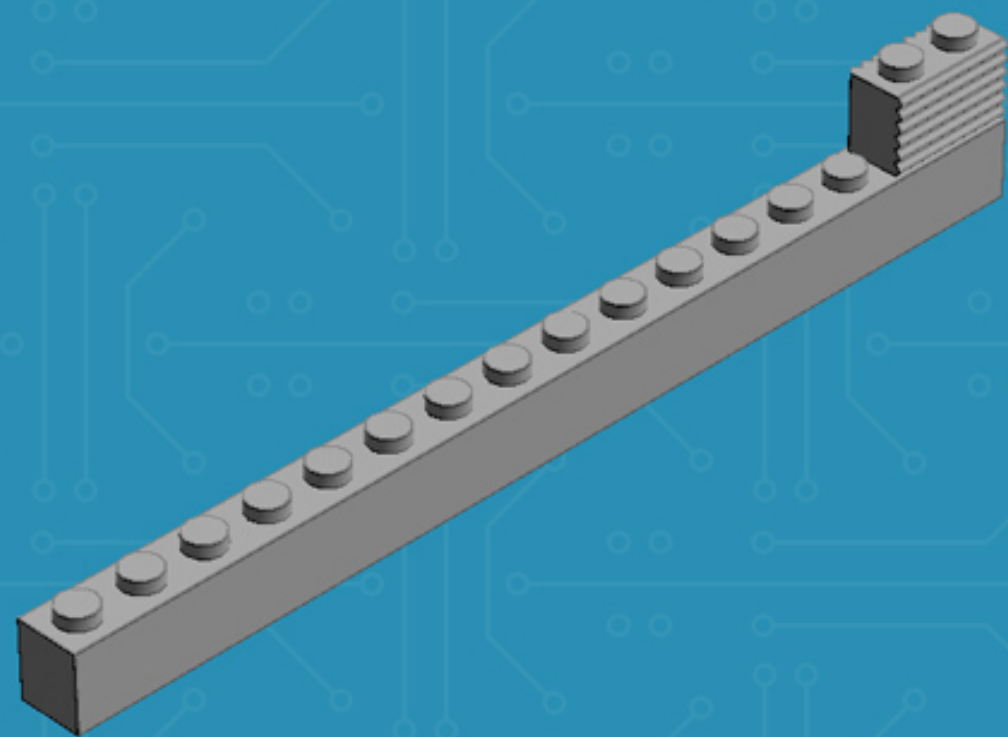


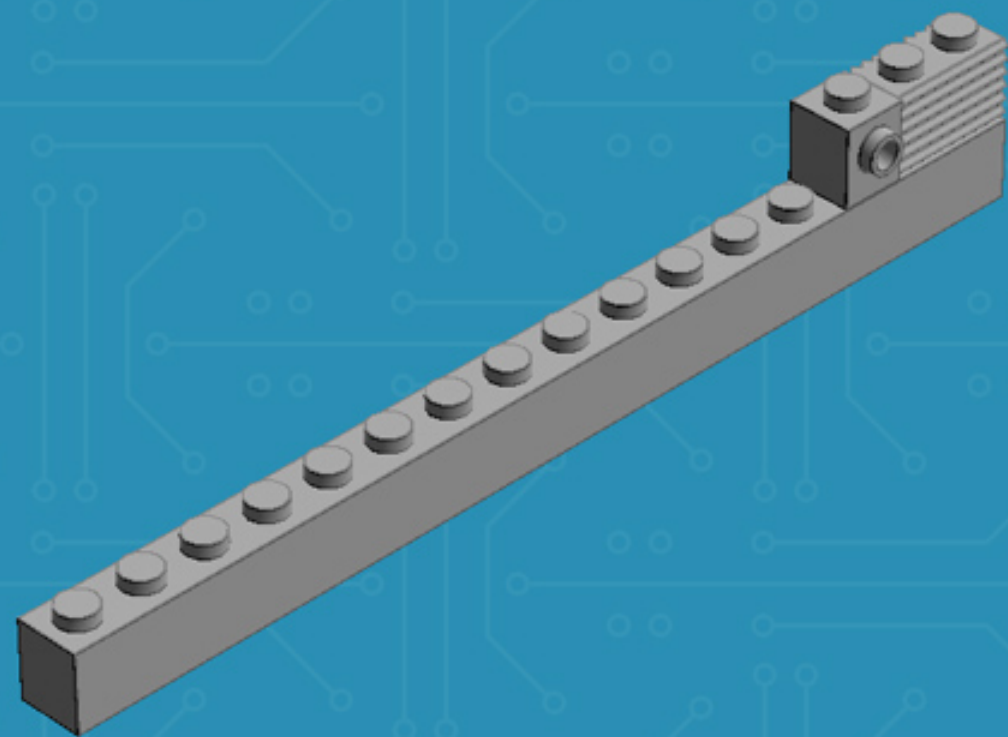


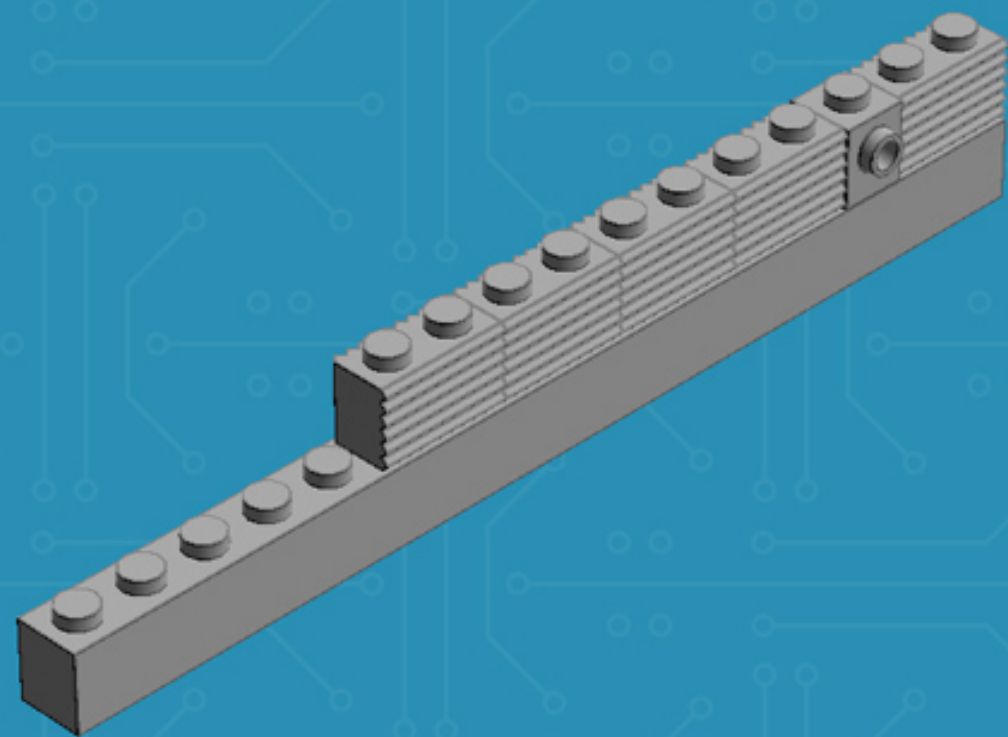


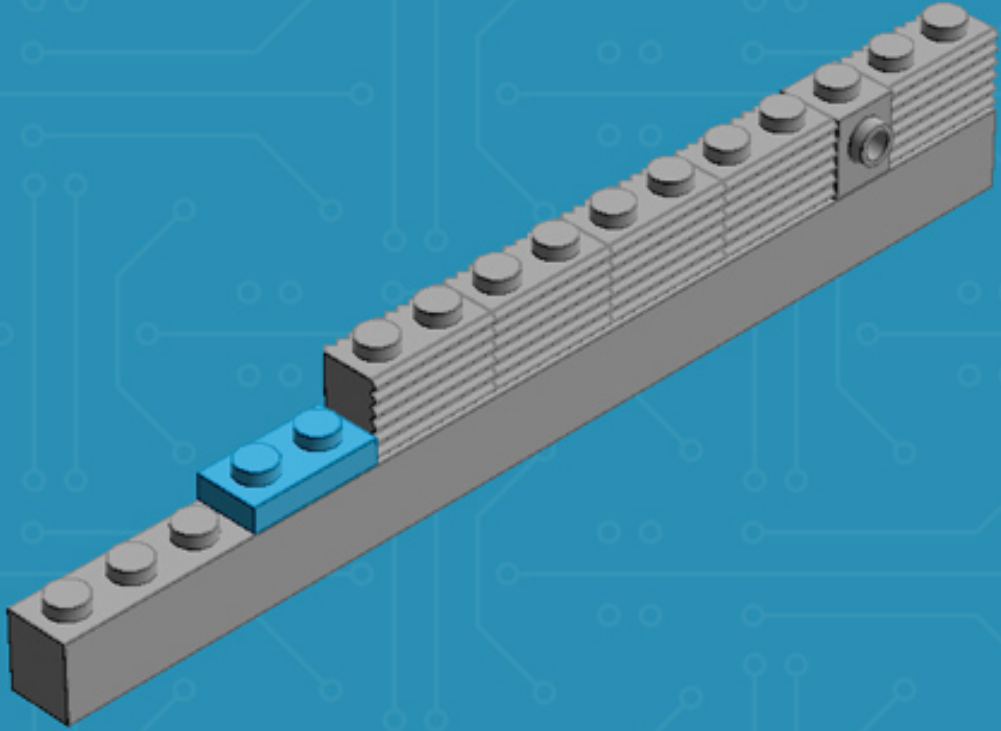


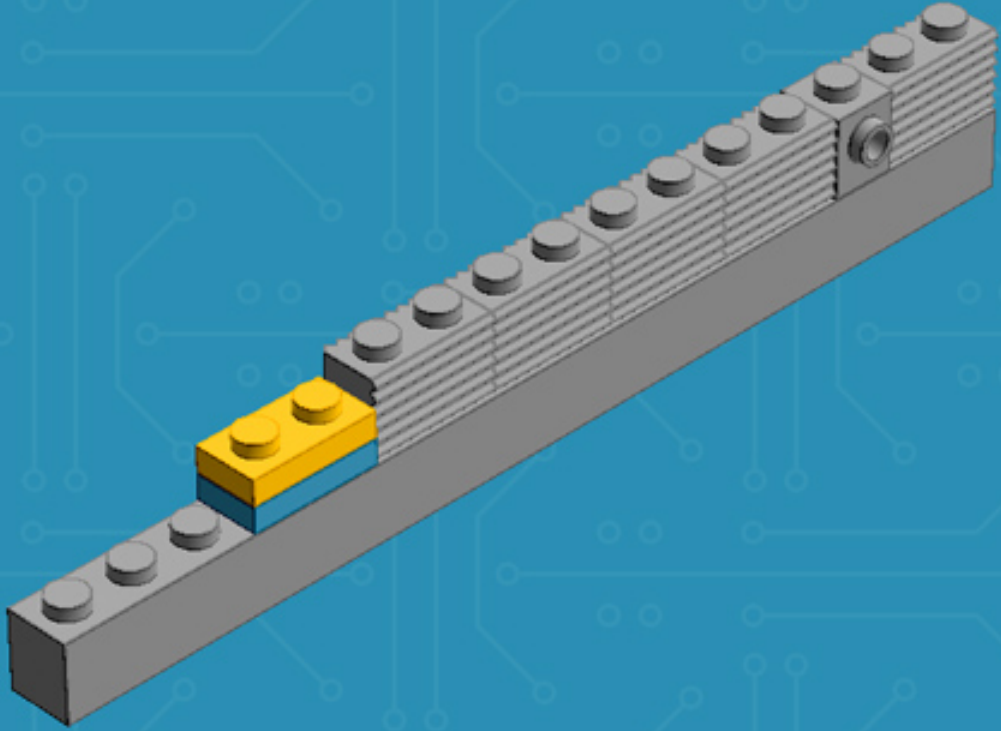


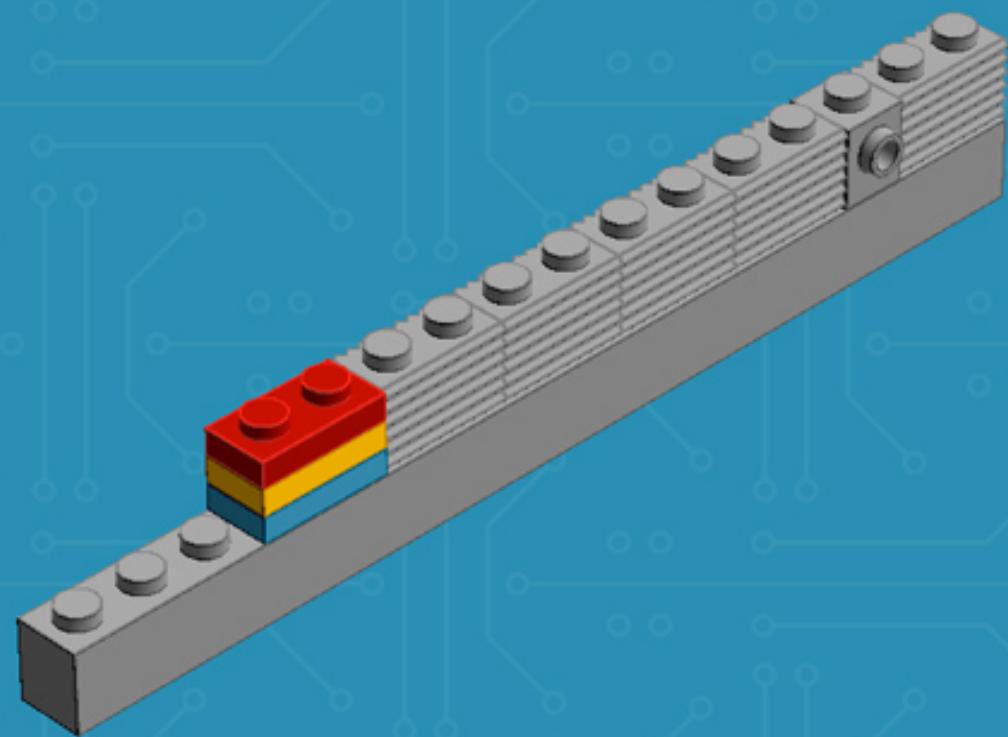


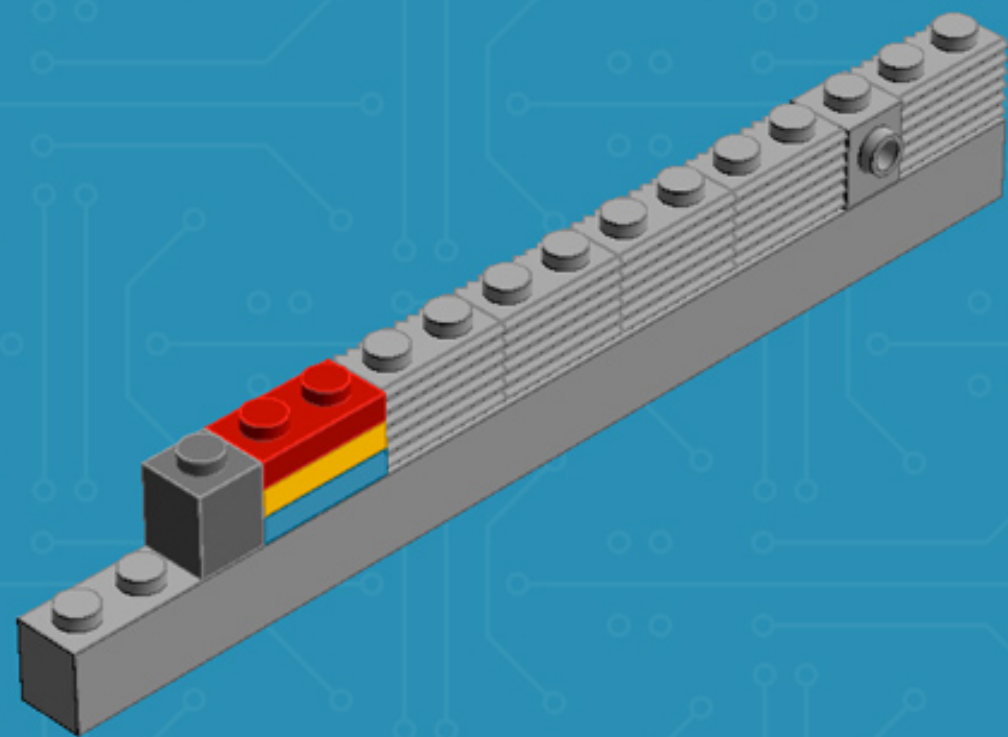


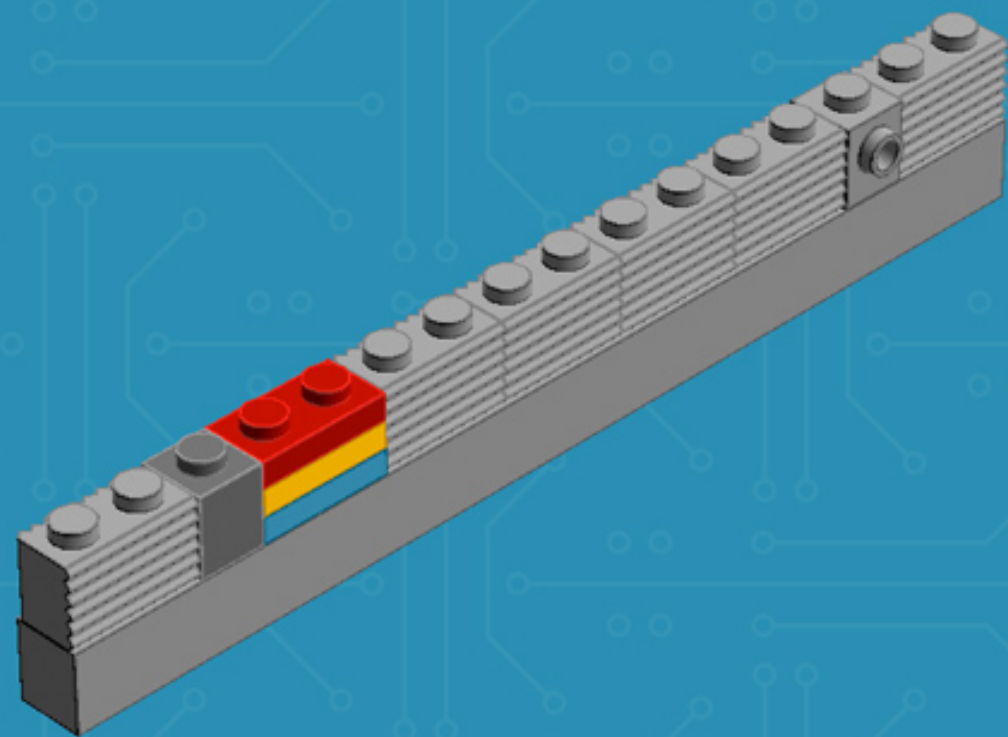


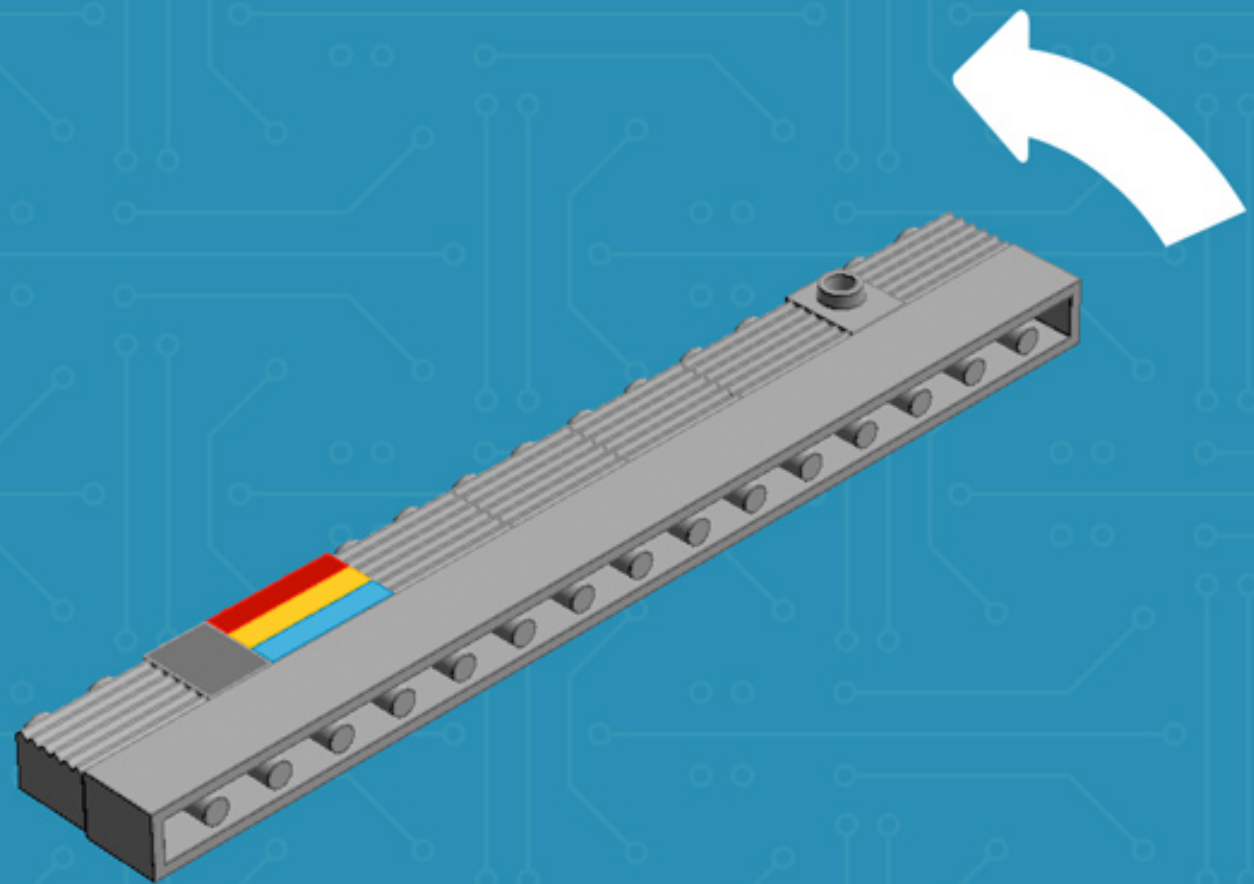


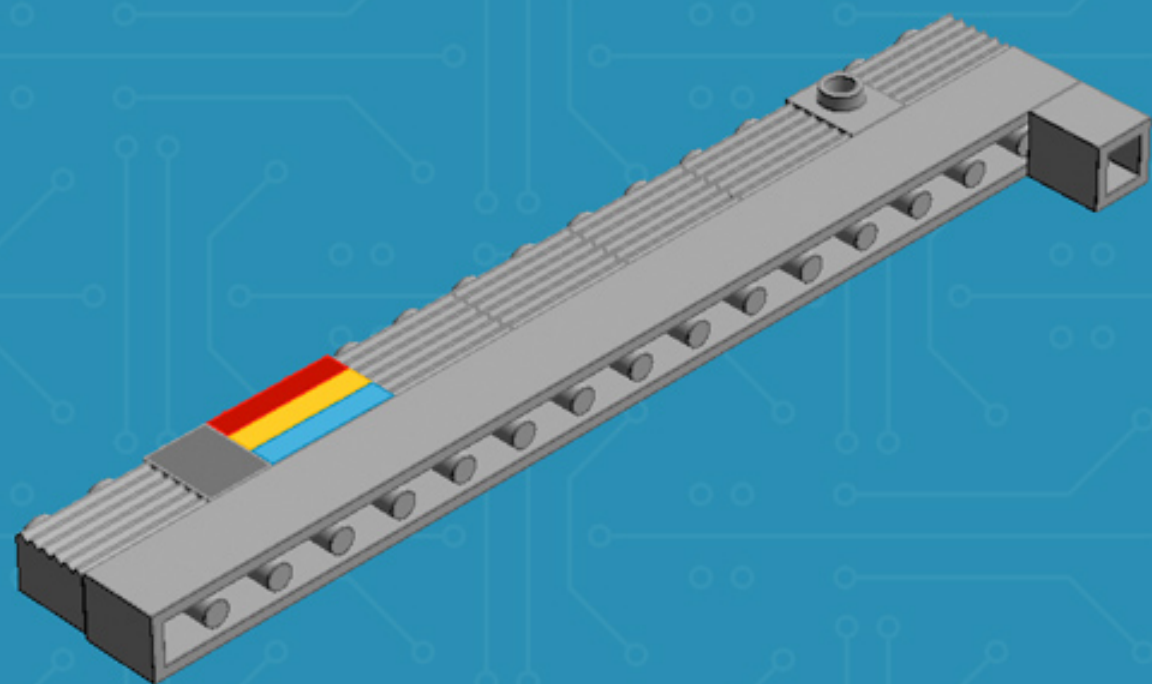


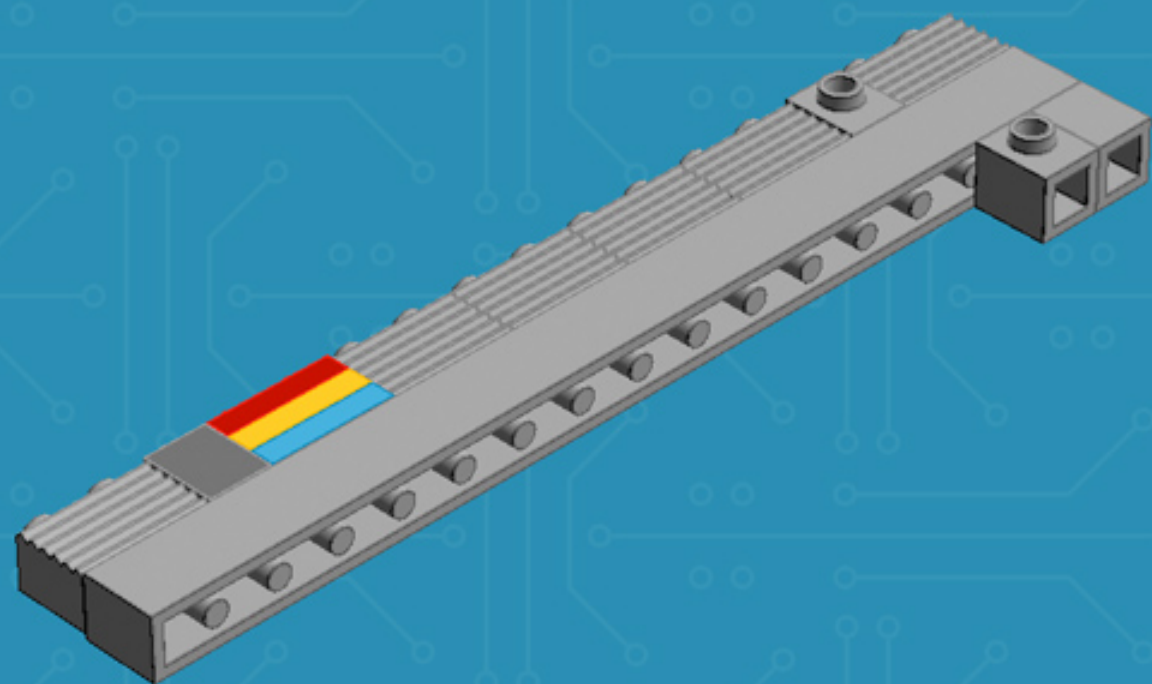


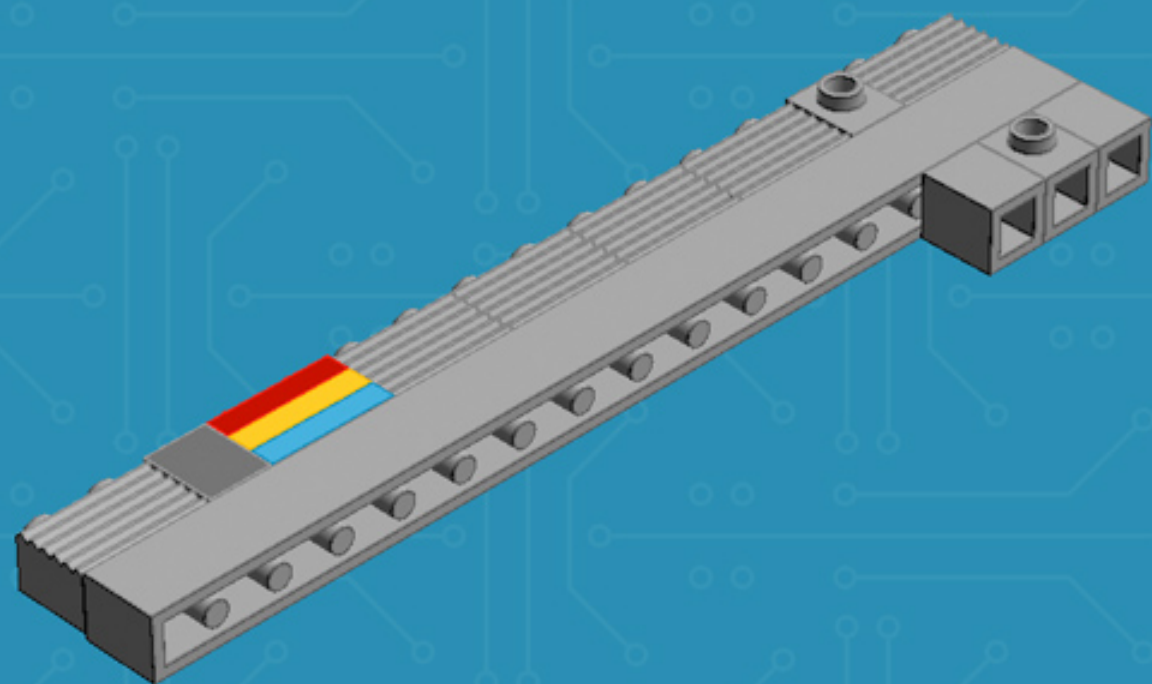


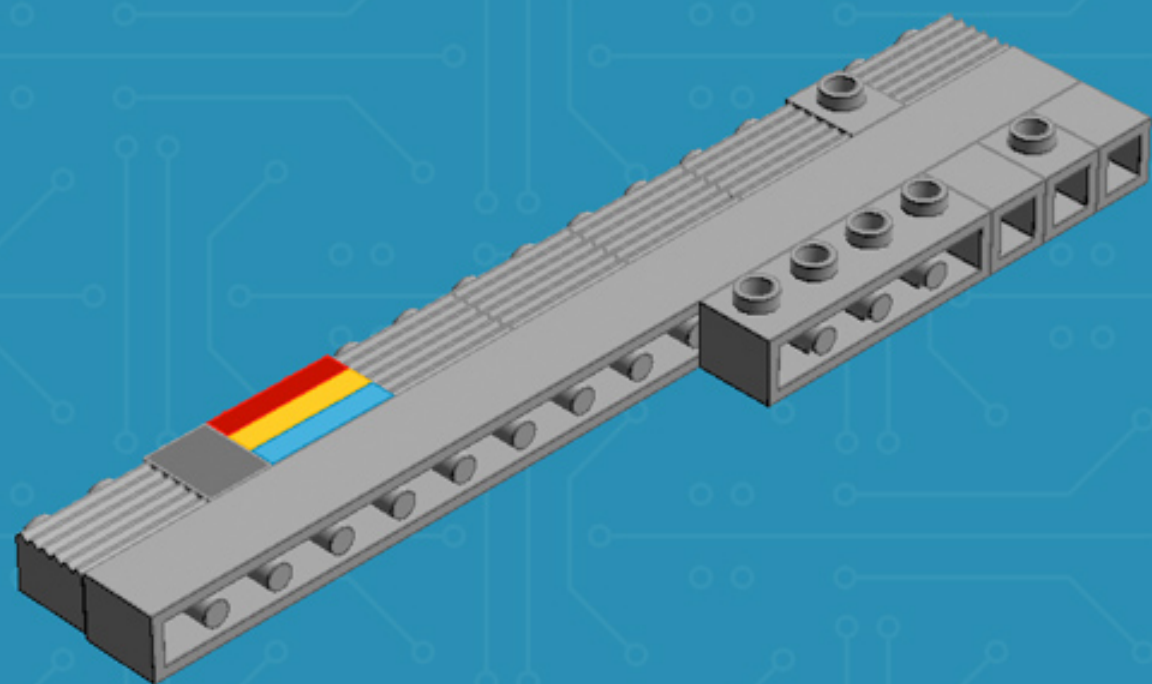


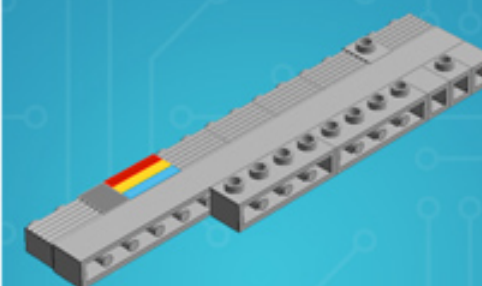
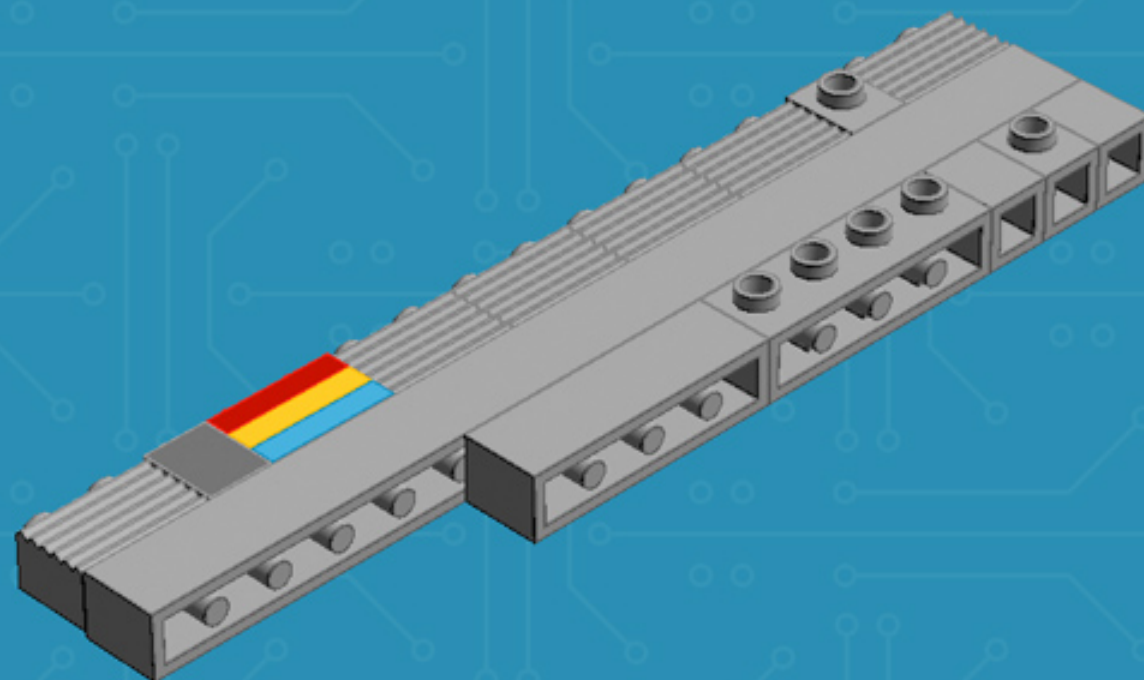






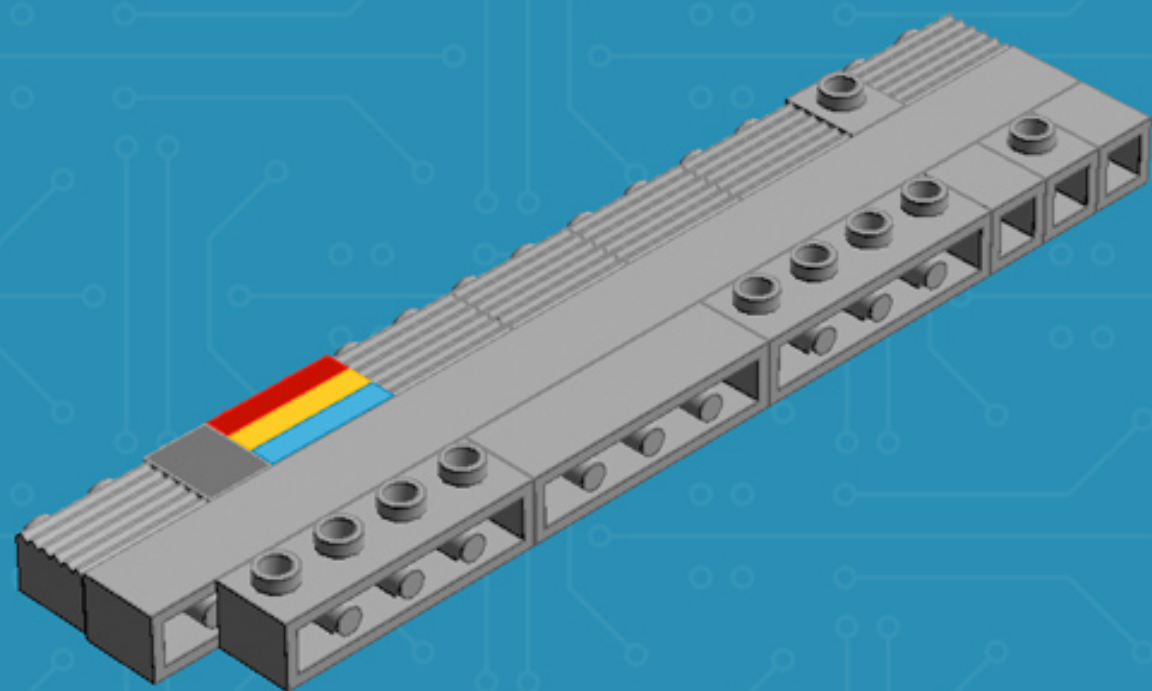


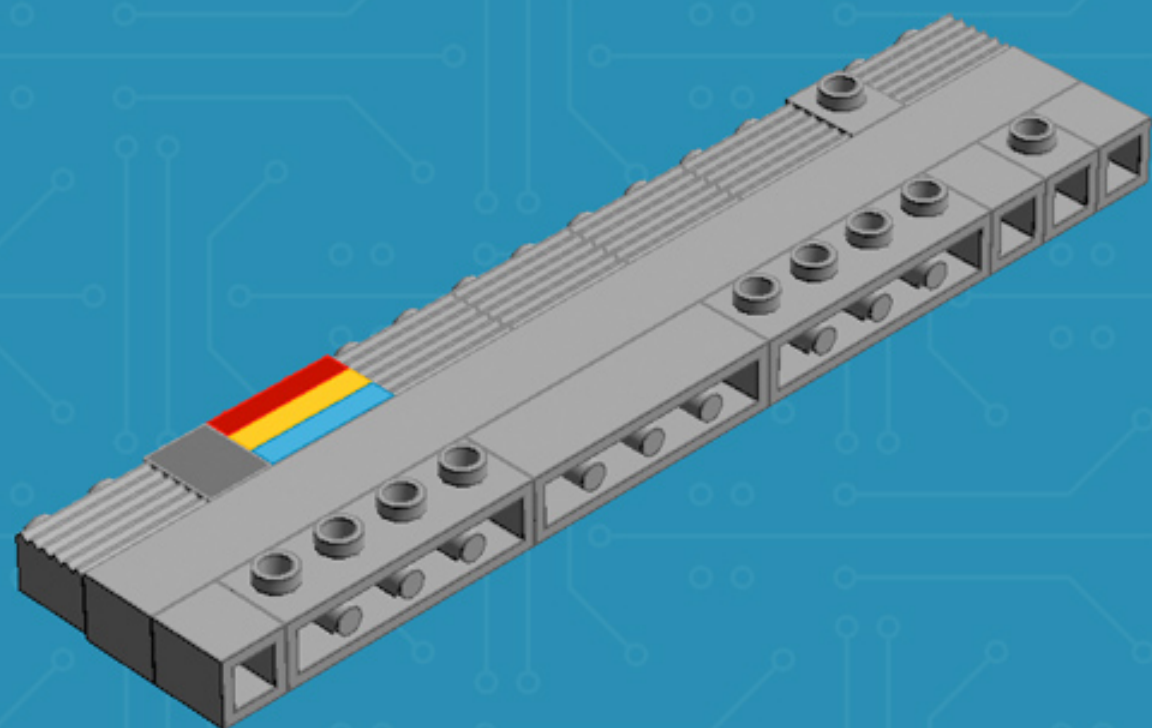


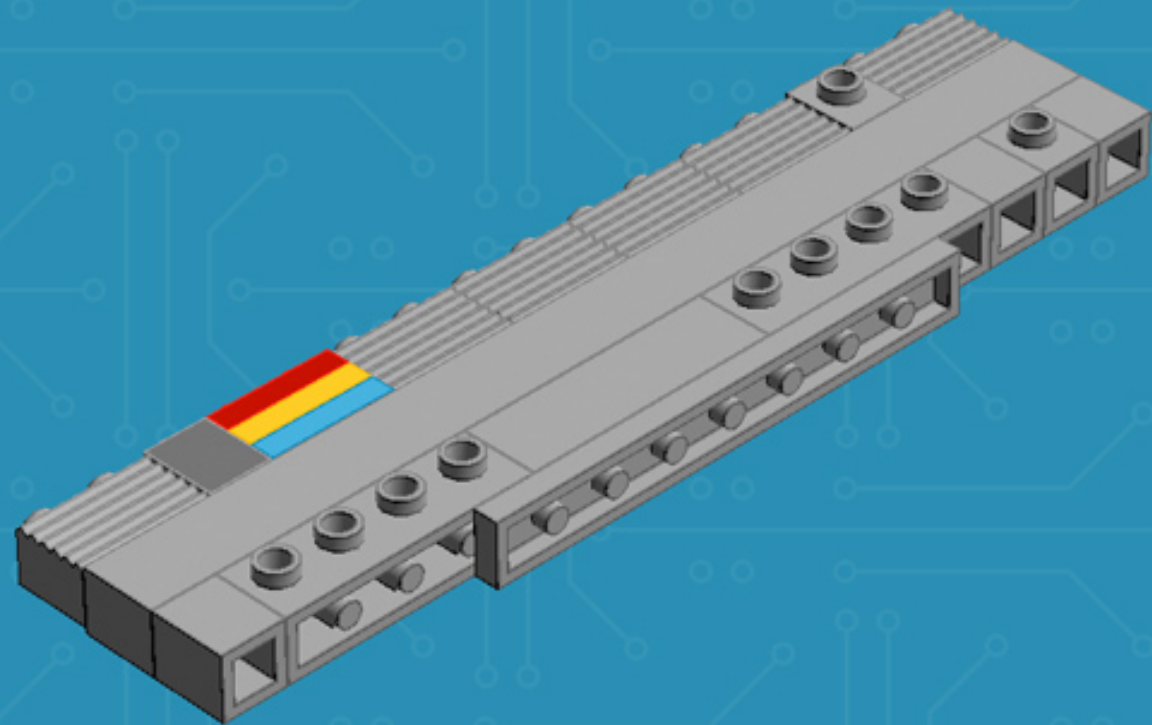


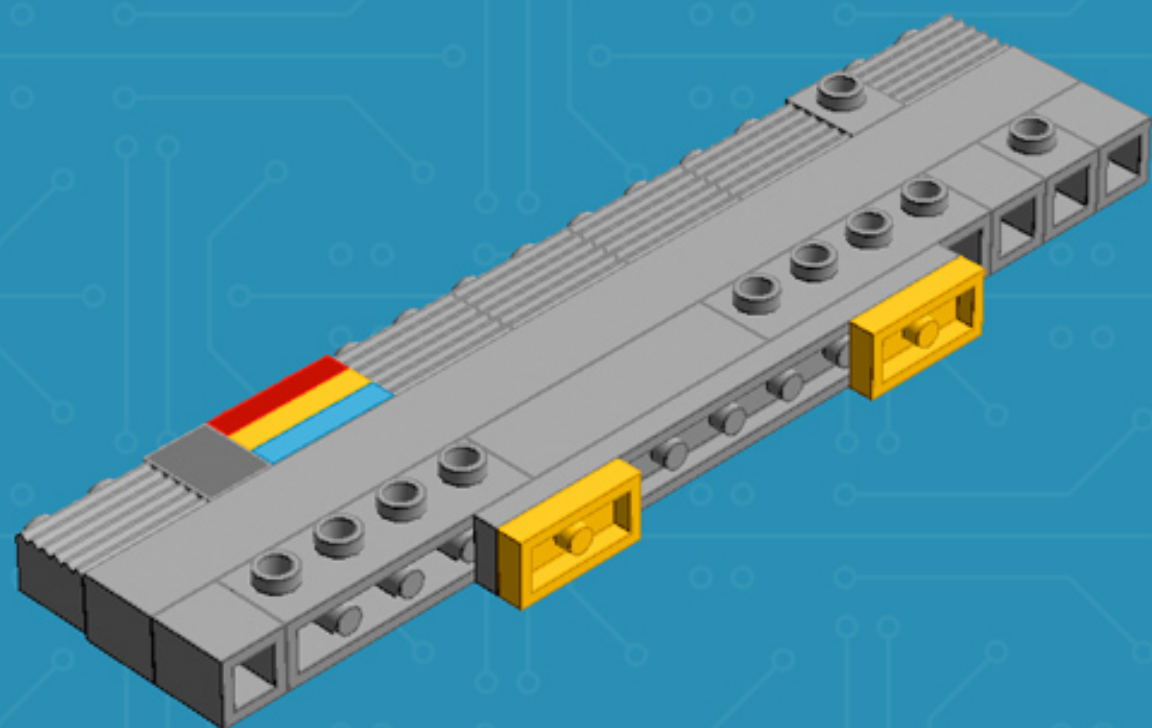
—NOTE—

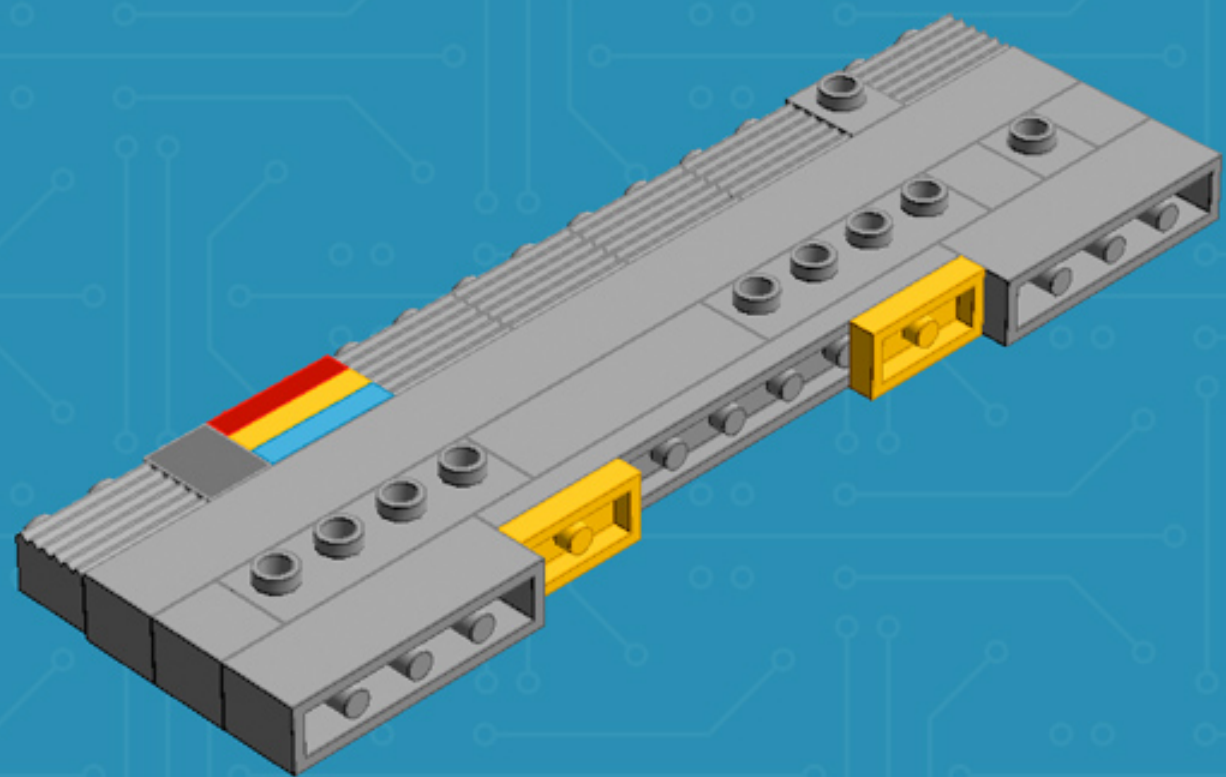
This step of the build has transitioned to a new part. In older kits, this step calls for another 1x4 brick with front-facing studs.

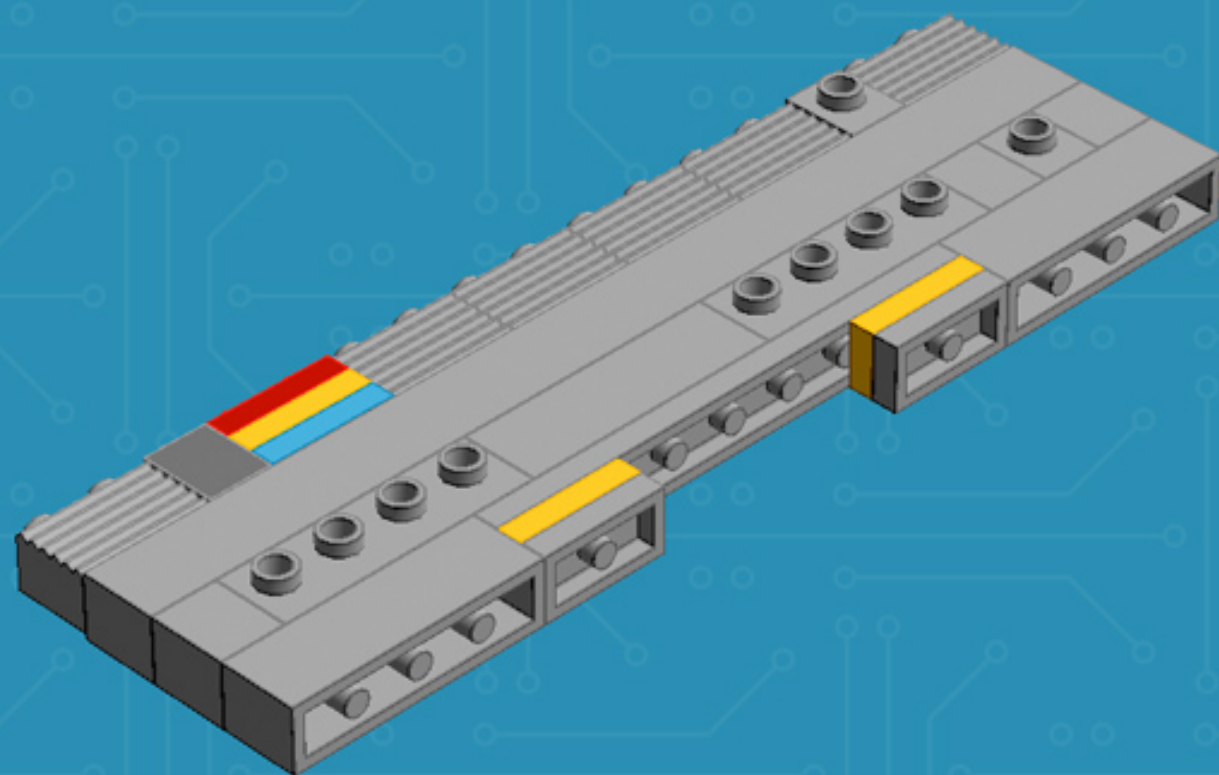


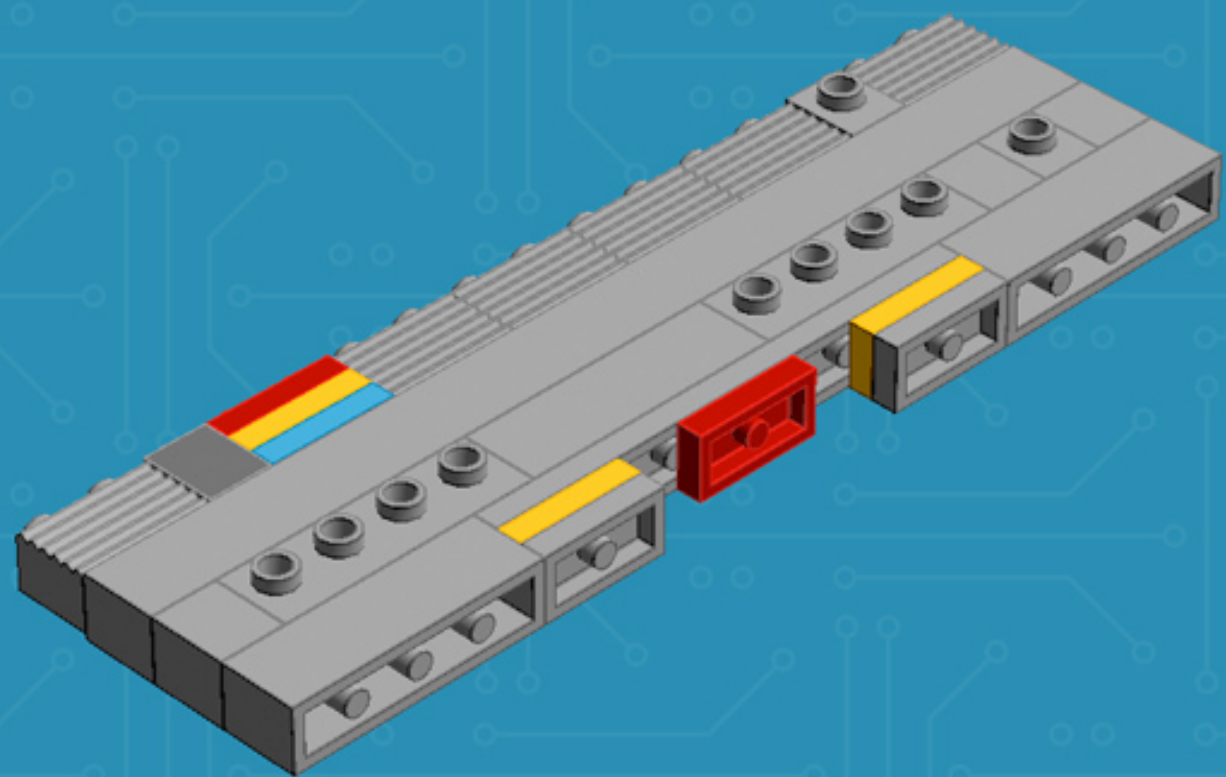


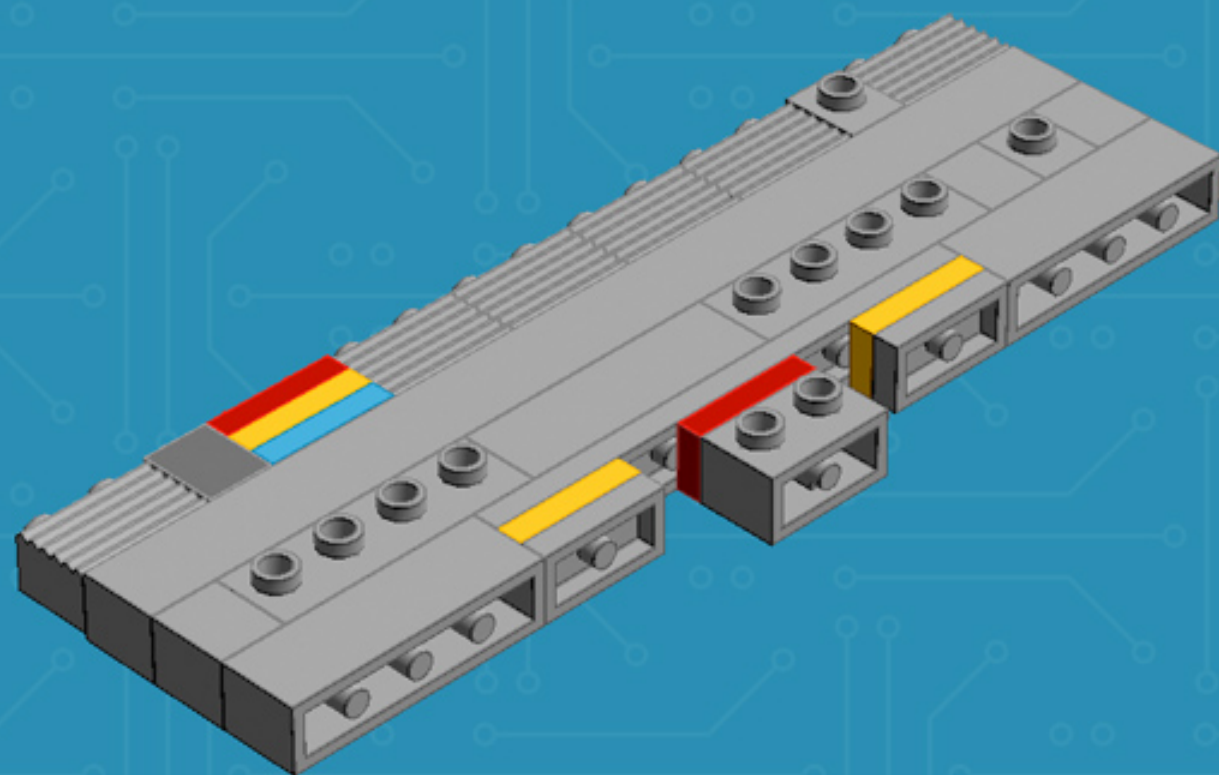


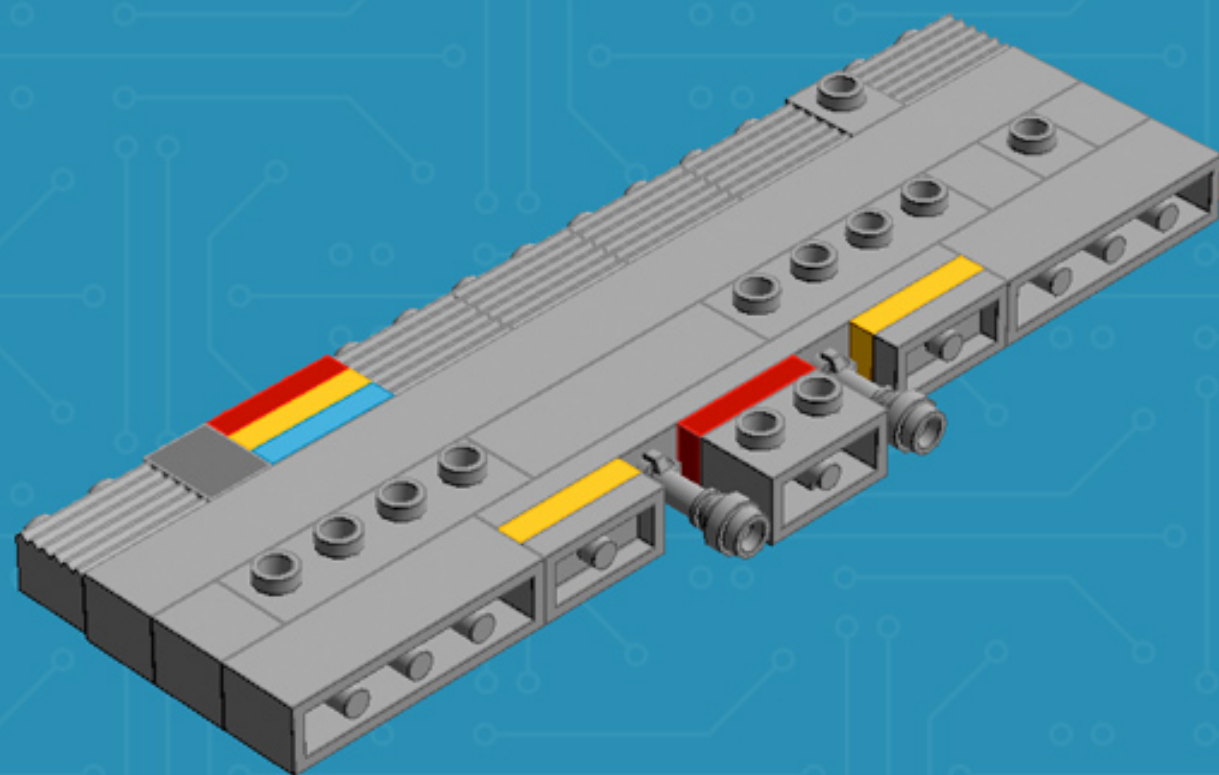


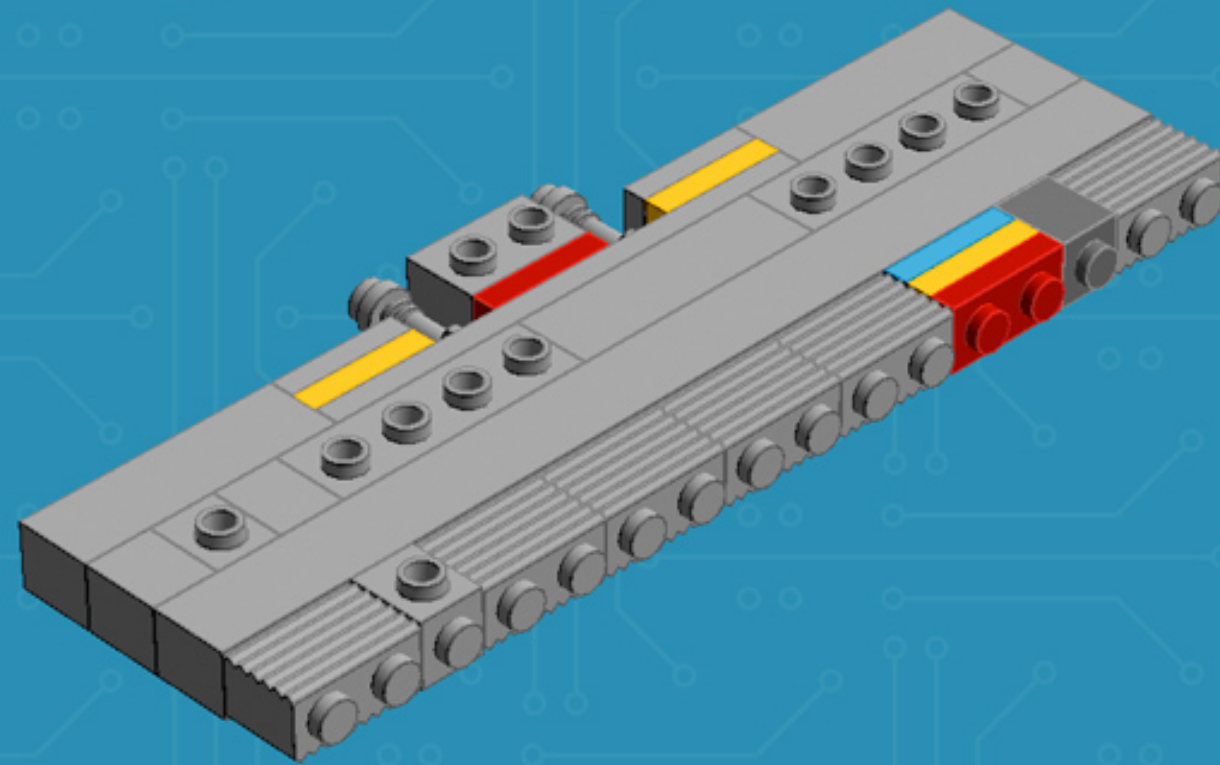


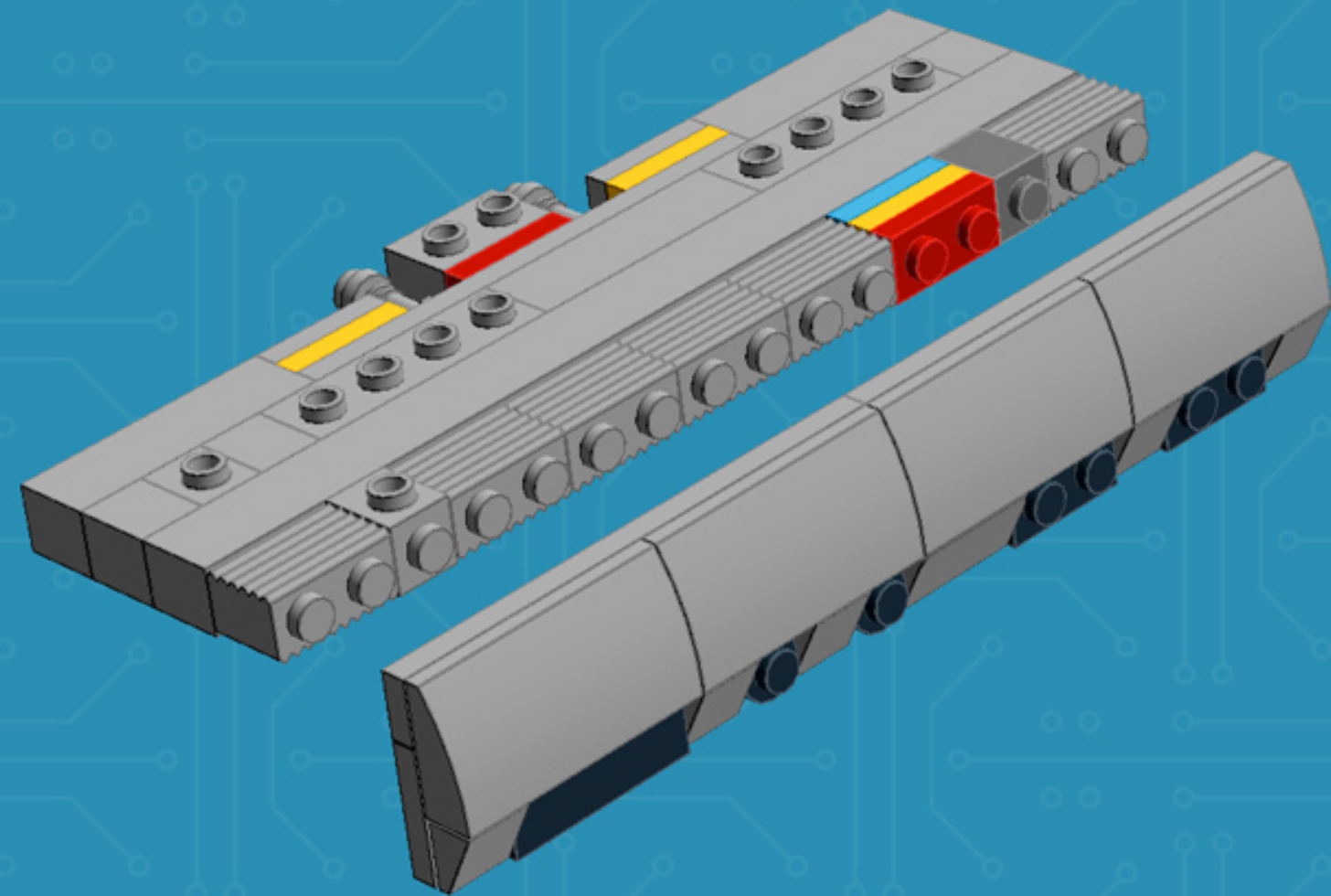


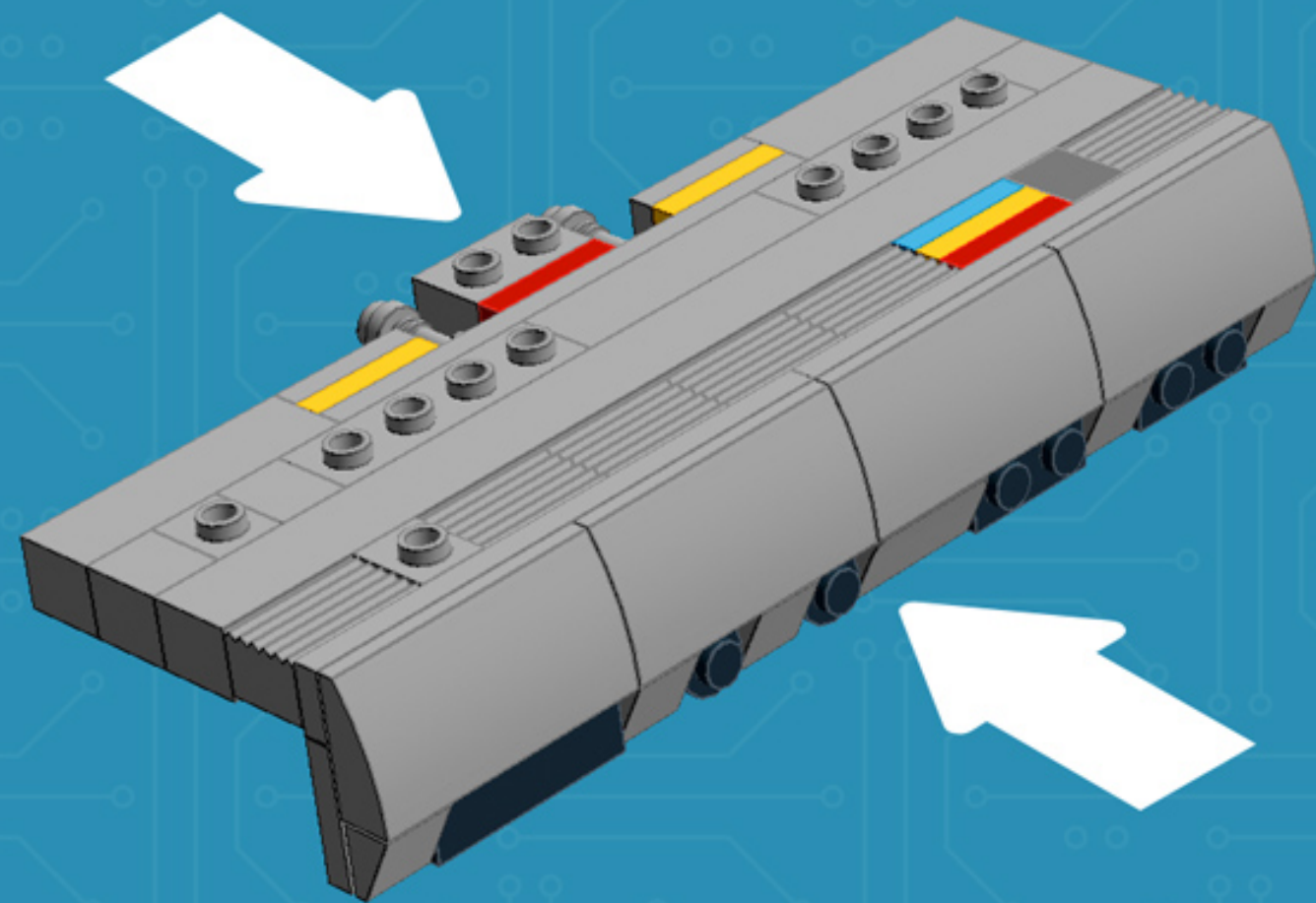


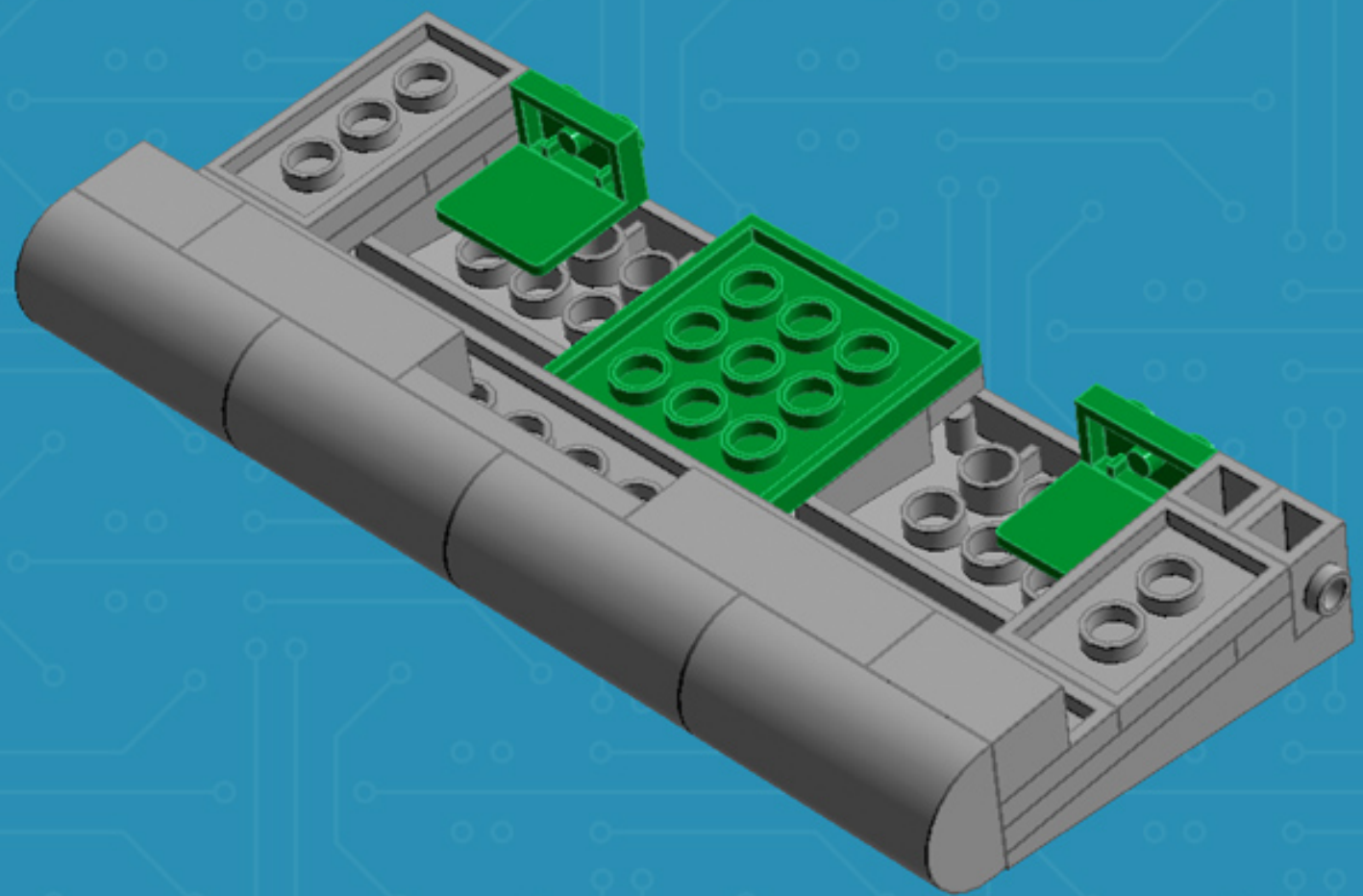


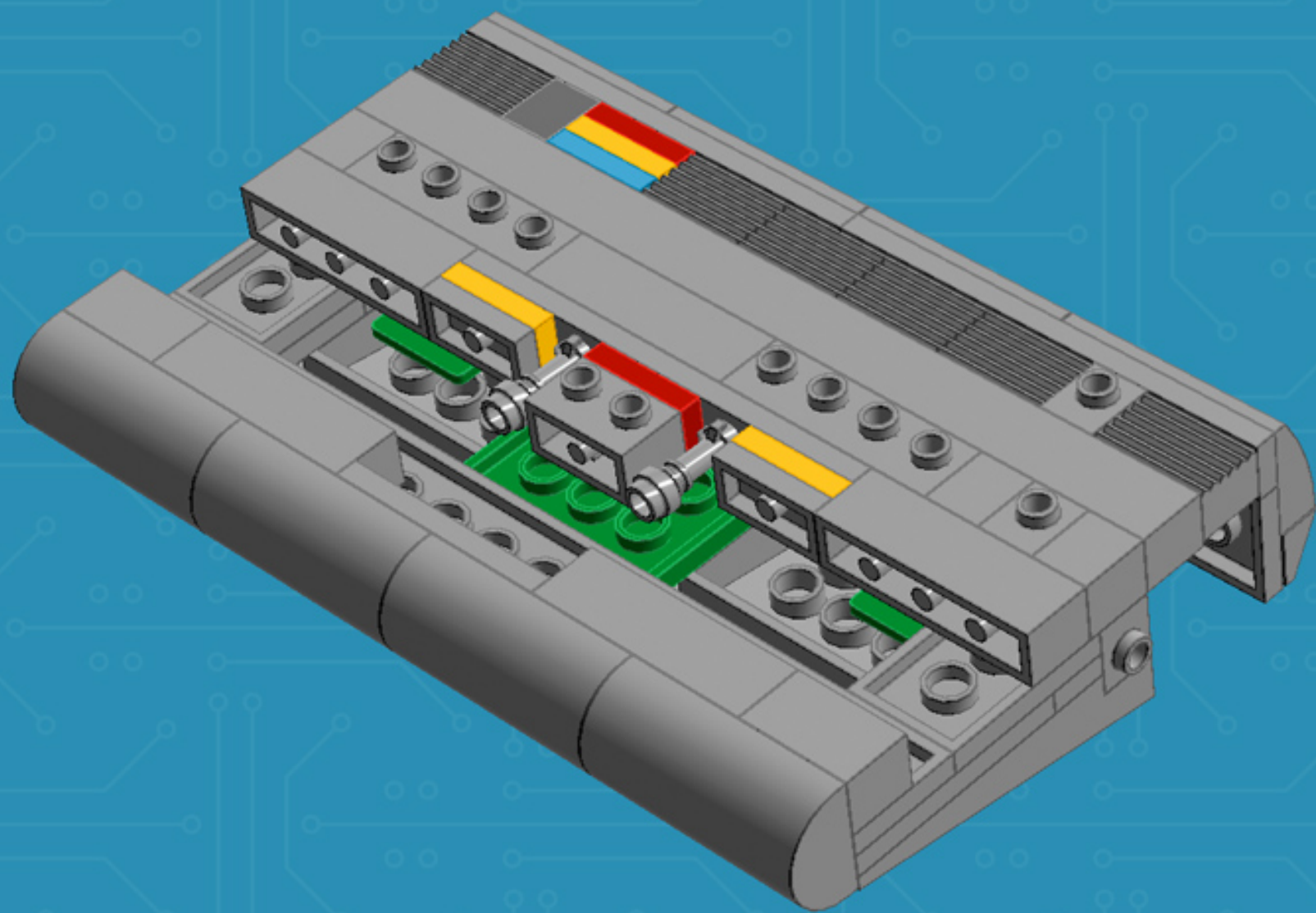


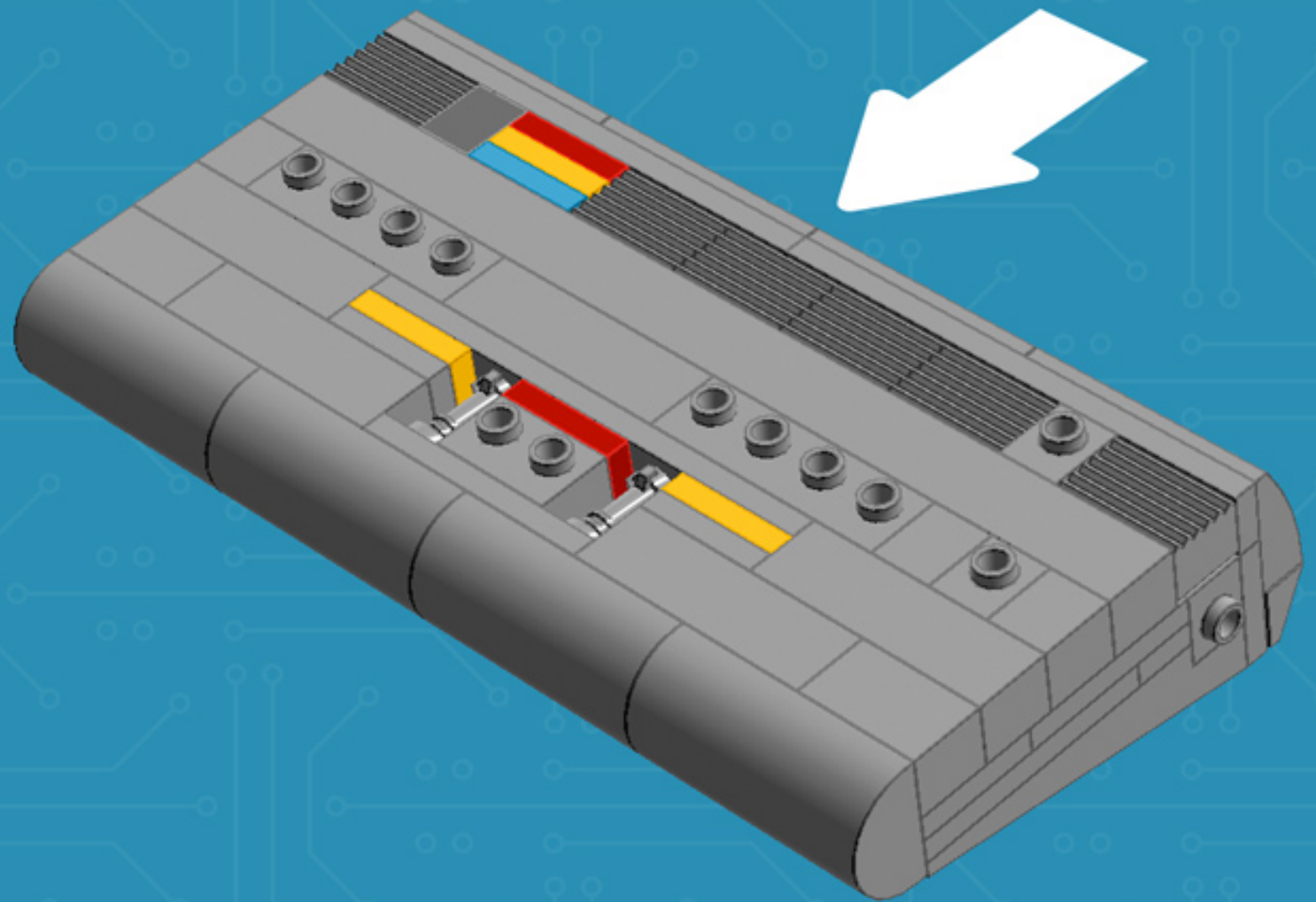


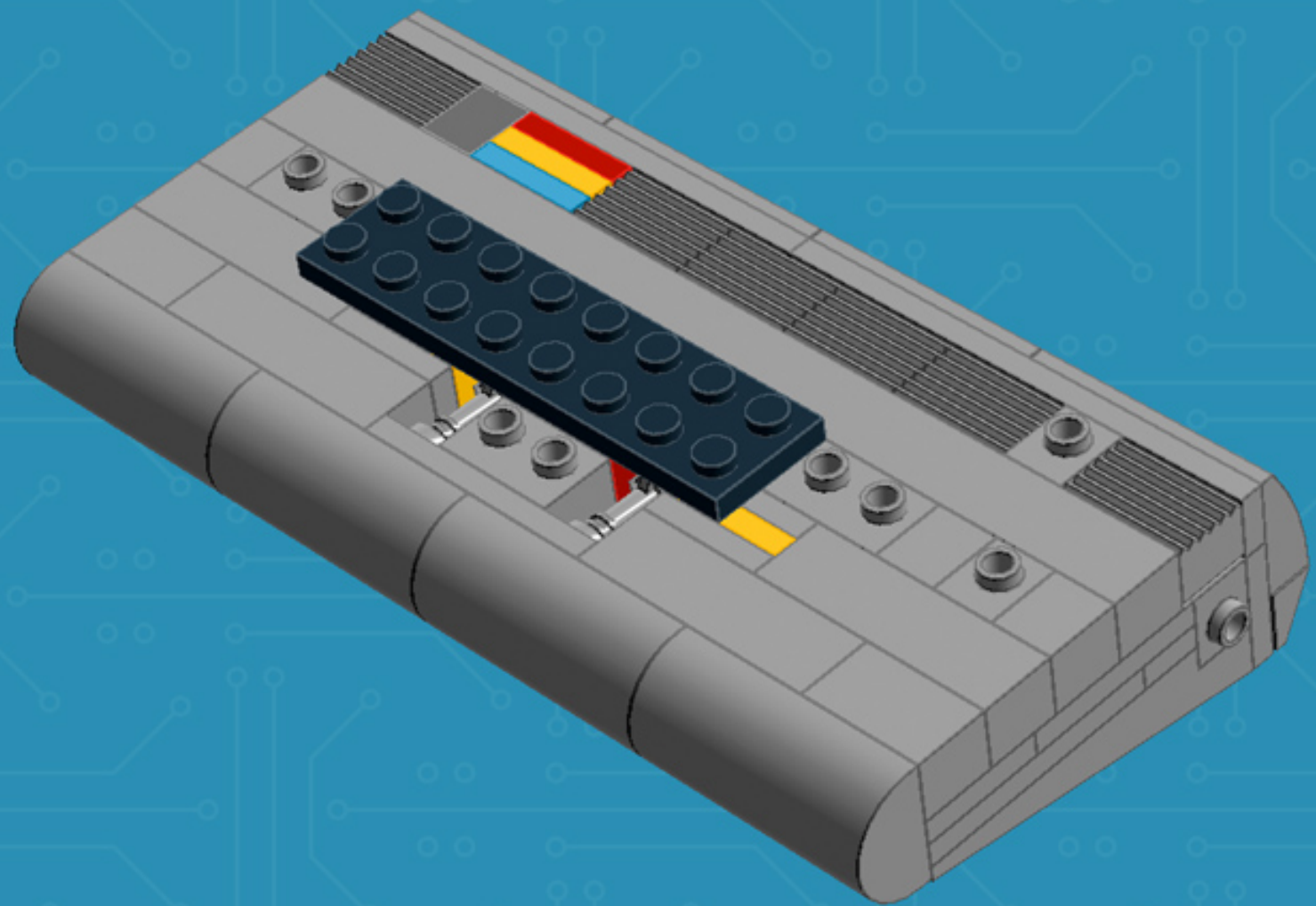


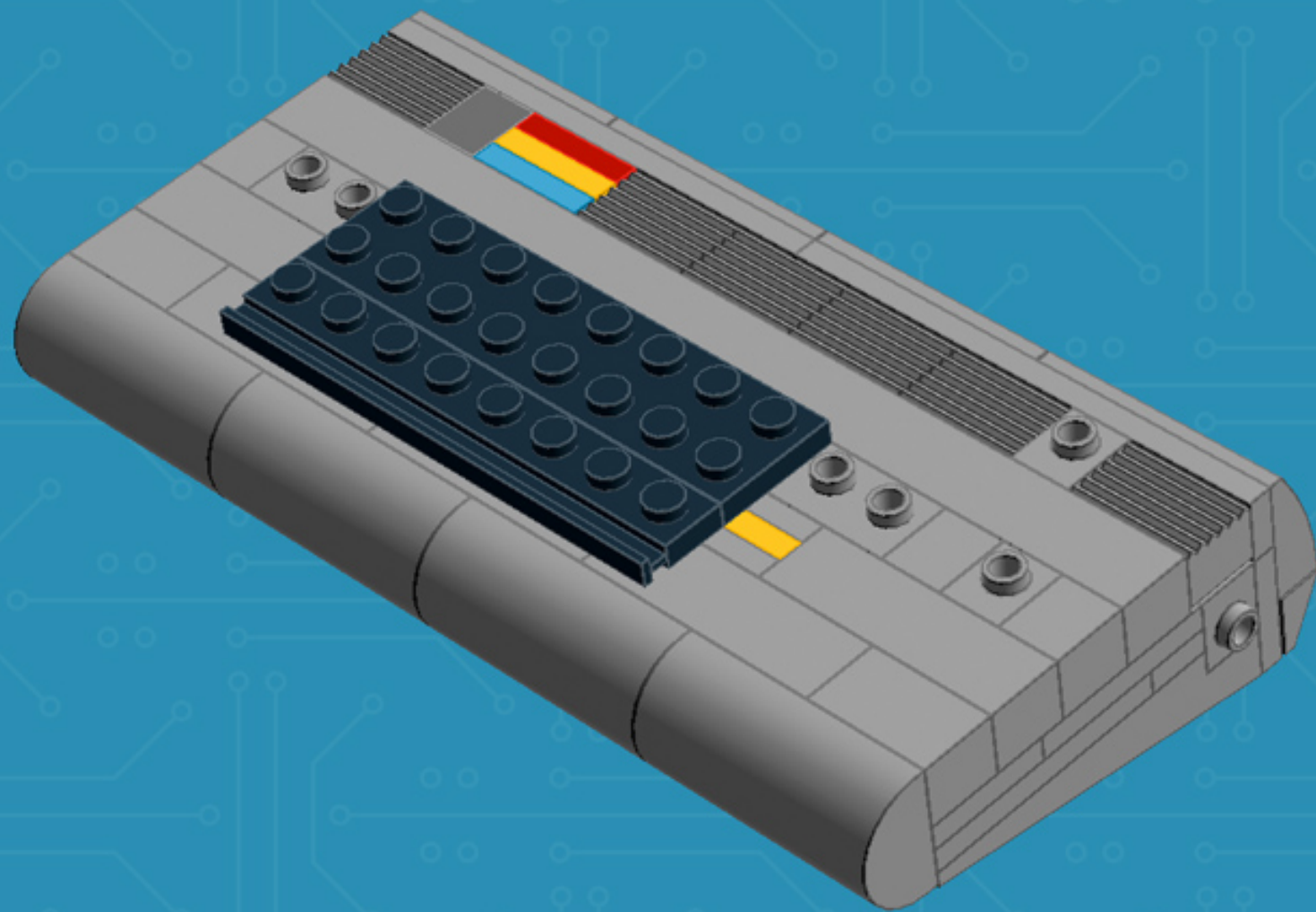










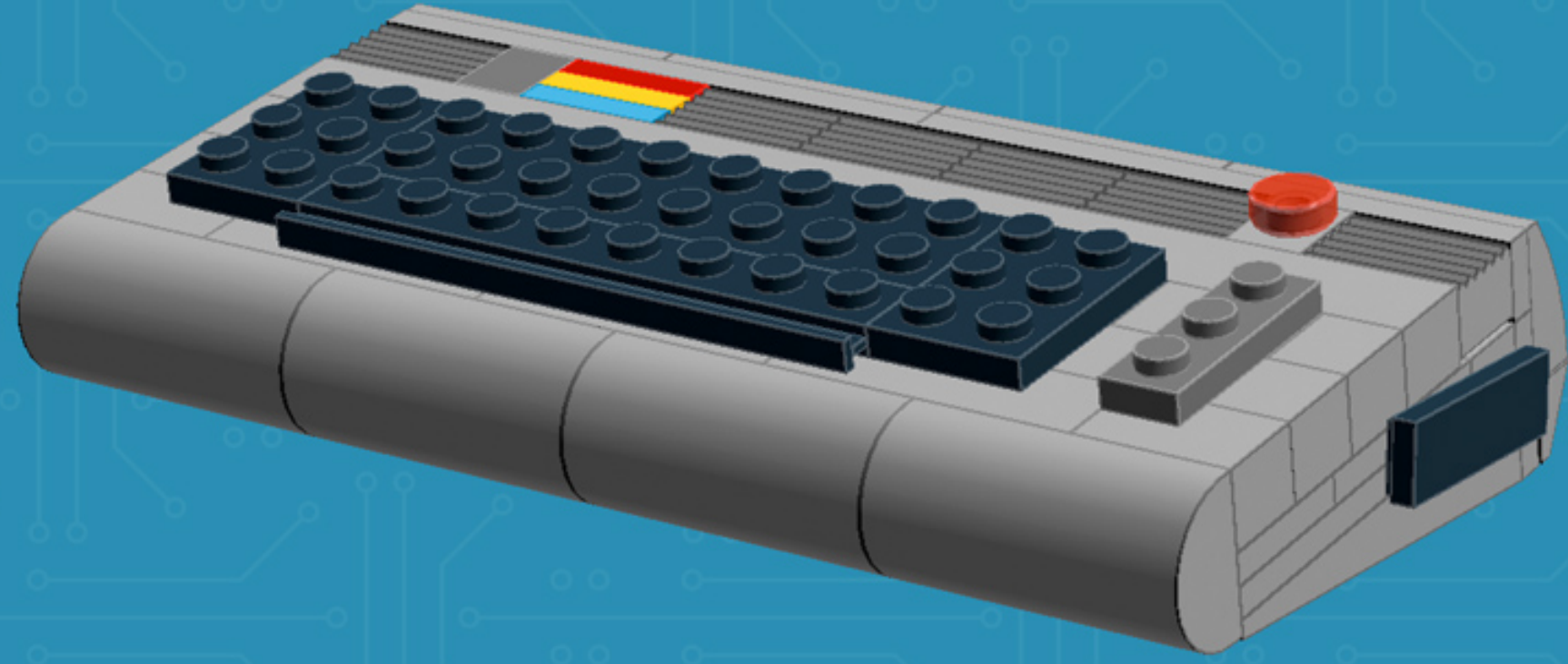












*For more fun builds,
please pop by flickr.com/powerpig,
visit me at facebook.com/c.mcveigh.photos,
or follow me on twitter [@actionfigured](https://twitter.com/actionfigured)*

Purchase custom building kits at powerpig.storenvy.com

© 2013 CHRIS MCVEIGH